

copyright © 2022



-
-
-

-
-
-
-
-
-
-
-

7*24h

7*24h

4008-111-000

4008111000@ruijie.com.cn

doc@ruijie.com.cn



APP

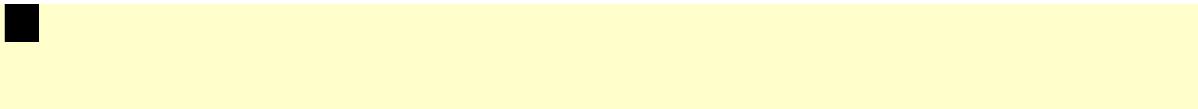

RG-S6220 3+G Ö ' j _ K @ \$ 5 5 8 k . D , ' M ' A Z] ö . Q ö Ö ~ 7 v 9 r IPv6 - ? Ö ' j É k ? ± Ä + X % Z] ö j
8 È j § 7 7 v Ö . ' = Ñ ~ È w 6 Š % Ö • Ä

RG-S6220 3+G Ö ' j -) È 3 ln kj Ö

x ñ » ' 10 G SFP+ Z5*1	10GB ase - T Z5*1	40G QSFP+ Z5*1	24/8G SFP FC Ö
------------------------	-------------------	----------------	----------------

RG-S6220-48XS4QXS()



 RG-S6220-48XS4QXS V1.XX 10G/40G DAC Direct Attach Copper SFP+

USB2.0

RG-S6220

1-4 RG-S6220-48XS4QXS

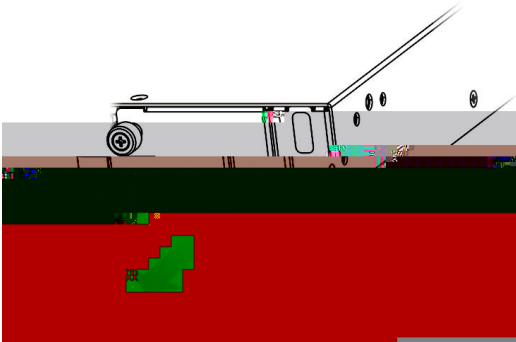

RG-S6220-48XS4QXS V1.XX

- USB Universal Serial BUS USB

	USB	USB	USB	USB
--	-----	-----	-----	-----

- Console RS-232 RJ45
- 10/100/1000M RCMI DCMI RJ45 Data Center Manageability Interface

	DCMI	PC	DCMI
--	------	----	------

DCMI

- SFP+ 48 10G QSFP+ DAC 1000Base-X
- QSFP+ 4 40G QSFP+ DAC 4x10G
- FC 8 2G/4G/8G Fibre Channel 1-8 SFP+

--	--	--	--

Status

			AC
			Link up
			Link up 1000M
			Link up 10M 100M
		/ /	

Fan



20cm



3

	RG-S6220-48XS4QXS V2.XX XX	
CPU	1.0GHz	
BOOT ROM	8MB	
Flash Memory	512MB	
SDRAM	DDR3 2GB	
	3 2+1	2
	M6220-FAN II-F	
	2 1+1	
	RG-M6220-AC460E-F	
	AC 100-240V~ 90-264V~ 50-60Hz 5.29A-2.2A	HVDC 192-290VDC 2.66A-2.03A
	<180W	

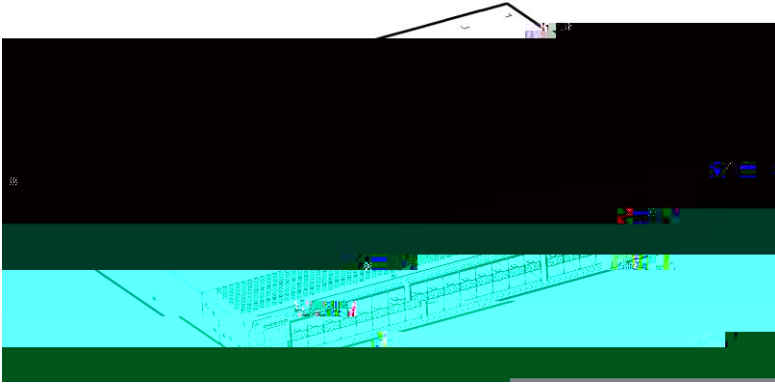

1-7 RG--

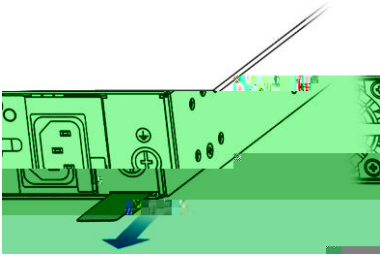

RG-S6220-48XS4QXS V2.XX

- USB Universal Serial BUS USB



USB

USB

USB

USB

- Console RS-232 RJ45
- 10/100/1000M MGMT RJ45
- SFP+ 48 10G QSFP+ DAC 1000Base-X
- QSFP+ 4 40G QSFP+ DAC 4x10G



	Status		
			1
			2

RG-S6220-48XS4QXS()

	(1*40G)		40G Link Up
			40G

RG-S6220-48XS4QXS V2.XX

RG-M6220-AC460E-F

	RG-S6220-48XS4QXS V2.XX	1	1
		1	1
		2	
		1	

RG-S6220-48XS4QXS V2.XX 0 50
 S6220-48XS4QXS V2.00
 3

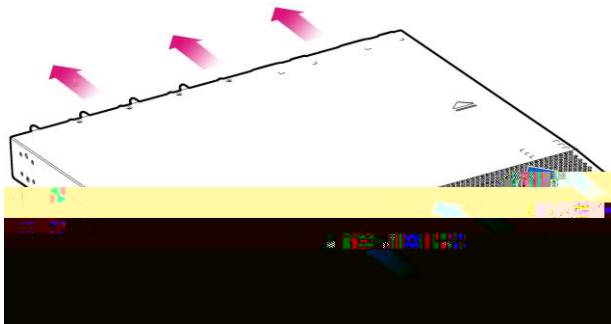

RG-S6220-48XS4QXS V2.XX M6220-FAN II-F

1-10 RG-S6220-48XS4QXS V2.XX



		20cm
	2	

	RG-S6220-48XT4QXS	
CPU	1.0GHz	
BOOT ROM	8MB	
Flash Memory	512MB	
SDRAM	DDR3 1GB	
	4	3
	M6220-FAN-F	
	2	1+1
	RG-M6220-AC460E-F	
	AC	HVDC
	100-240V~ 90-264V~ 50-60Hz 5.29A	192-290VDC 2.66A-2.03A
	<450W	

	A B
	
SFP+	
QSFP+	
FC	
10Gbase-T	 A
EMC	GB/T 9254.1
	GB 4943.1
	0 to 45°C
	-40 to 70°C
	10% 90% RH
	11KG 4 2
	440 * 500 * 44 L * W * H mm 1RU

 RG-S6220-48XT4QXS 40G DAC Direct Attach Copper QSFP+ 3
B

RG-S6220-48XT4QXS

- 2 1+1
- 4 3+1

1-11 RG-S6220-48XT4QXS

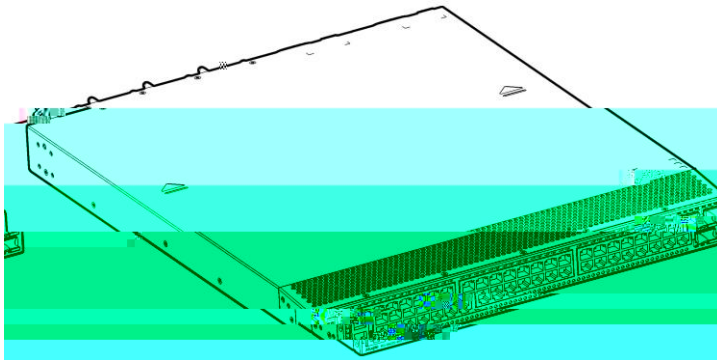

1-12 RG-S6220-48XT4QXS

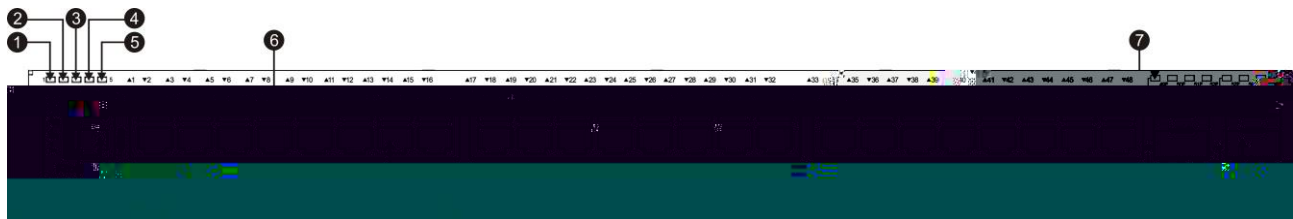

PWR1	40G QSFP+
PWR2	10/100/1000Base-T RCM
RCMI	Console
	10GBASE-T RJ45
10GBASE-T	⑪ 40G QSFP+

- 10GBase-T 48 10GBase-T 1000Base-T 100Base-TX
- QSFP+ 4 40G QSFP+ DAC 4x10G

	Status		1
			2
1	PWR1		AC
2	PWR2		AC
			Link up
RCMI	RCMI		Link up 1000M



20cm



3

	RG-S6220-24XS
CPU	1.0GHz



USB2.0

RG-S6220

()
1-19 RG-S6220-24XS

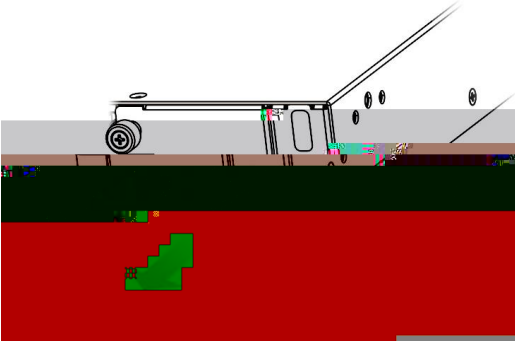

RG-S6220-24XS

- USB Universal Serial BUS USB

 USB USB USB USB

- Console RS-232 RJ45

- 10/100/1000M RCMi DCMI RJ45 Data Center Manageability Interface

 DCMI PC DCMI

 DCMI

RCMI	RCMI		Link up		
			Link up	1000M	
			Link up	10M	100M
		/ /			
	Fan		3		
		1			
		2		3	
SFP+	1F—24F		Link		
			10G/1G	Link Up	
			10G/1G		

RG-S6220

1-22 M6220-02QXS

Status
1F~8F, 9F 10F
40G QSFP+

M6220-02QXS 2 QSFP+

DAC

QSFP+



	Status		
	1F~8F (4*10G)		Link 10G Link Up

QSFP+



 M6220-02QXS QSFP+ 40G 4x10G

EMC	GB/T 9254.1
	GB 4943.1
	0 to 50°C
	-40 to 70°C
	10% 90% RH
	0.5KG
	224.5 * 110 * 36.8 L * W * H mm

 M6220-08FC	FC	Ethernet				
 M6220-08FC	Ethernet		10G SFP+	1G SFP	10G SFP+	1G SFP
 M6220-08FC	10G	B	DAC	Direct Attach Copper	SFP+	1 3
5						

1-24 M6220-08XT

Status
1~8
10GBASE-T RJ45

M6220-08XT 8 RJ45 10GBASE-T 1000BASE-T 100BASE-TX

	Status		
	1-8		Link up 10G/1G/100M Link up

	10Gbase-T 1000Base-T 100Base-TX
--	---------------------------------



1-26 M6220-FAN II-F

1

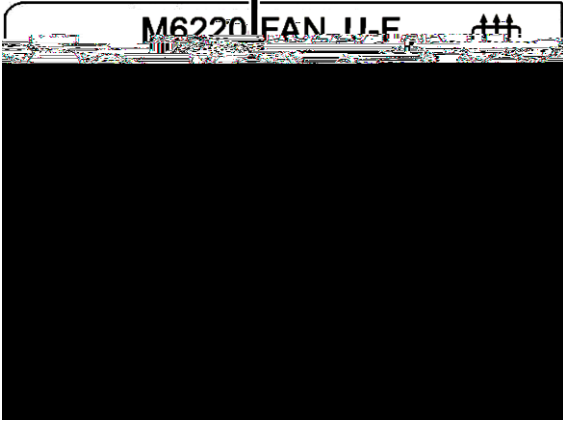

Status

	Status		

	M6220-FAN II-F
	20CFM
	18000RPM
	6W
	0.25KG
	166 * 55.7 * 41.2(mm)

M6220-AC460E-F RG-S6220

RG-S6220

M6220-AC460E-F

M6220-AC460E-F

RG-S6220-48XS4QXS()

	243.2 * 86.4 * 39.9 L * W * H mm
	10A

M6220-DC460E-F RG-S6220

RG-S6220

M6220-DC460E-F

RG-S6220

-48V

--	--	--	--



RG-S6220



120VAC

0.5mA

240VAC

1.0mA

RG-S6220

-
-
-
-

RG-S6220

RG-S6220

RG-S6220

20cm

3

RG-S6220

-
-
-

RG-S6220

--	--	--

RG-S6220-24XS

0.5 μ m	/ m ³	3.5 \times 10 ⁶
5 μ m	/ m ³	3 \times 10 ⁴

...

-
-
-
-

...

...

 RG-S6220



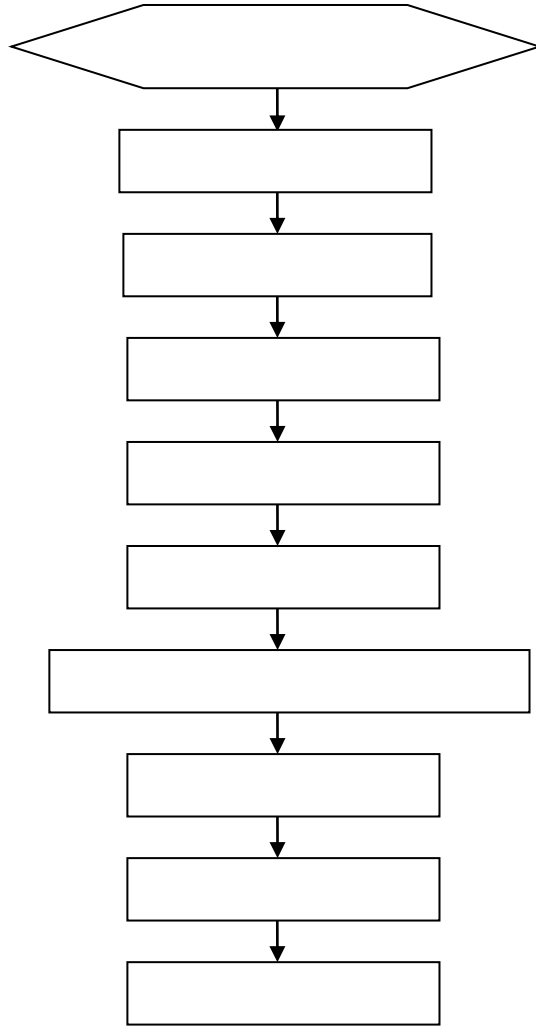

■

■

■

■

.....

■

■

■

■

5mm

■

■

■

■

■

RG-S6220

10mm

-
-
-
-

1 L 8 M4*8FMO

2 4 M4*8FMO

3-1

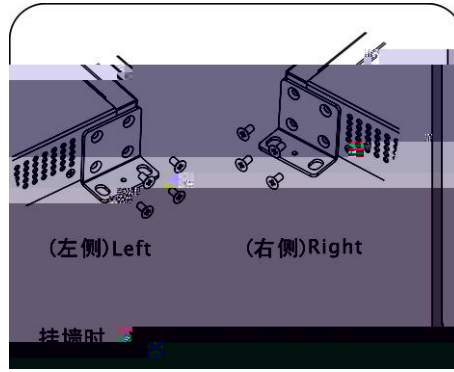
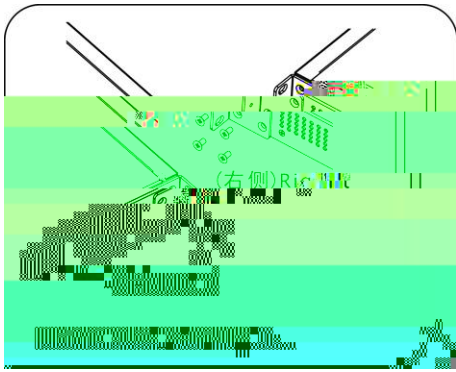

RG-S6220

EIA

19

RG-S6220

3-2

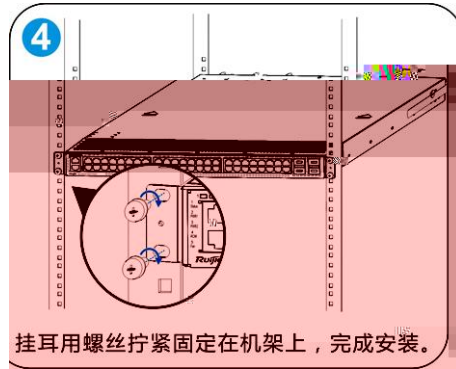
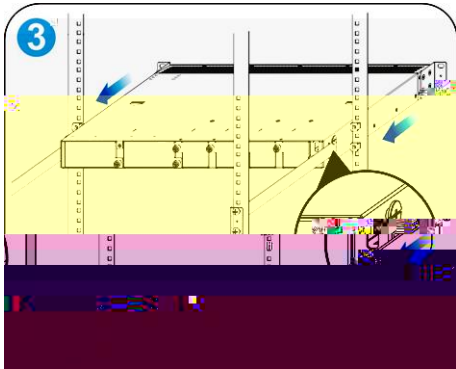
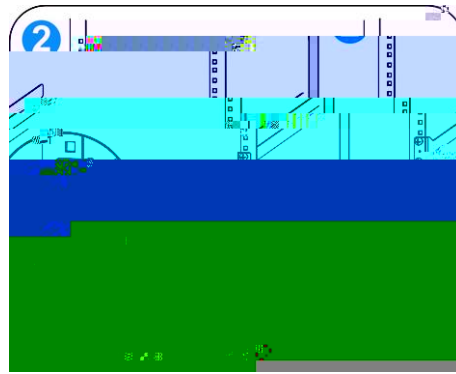
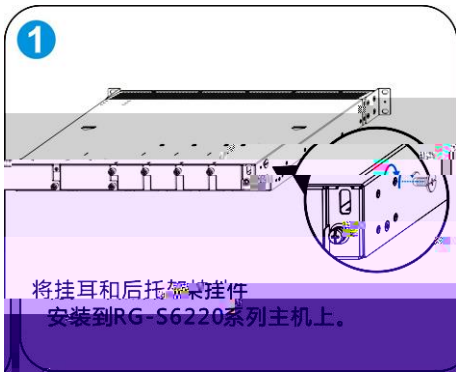

800mm – 1200mm

1

4

2

3-3

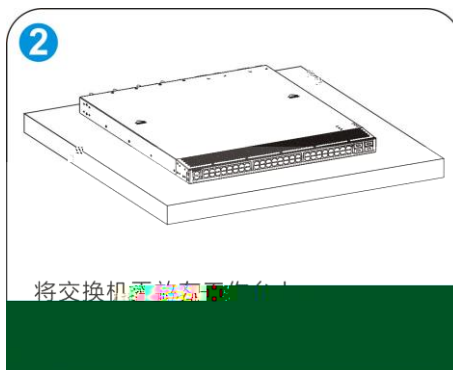
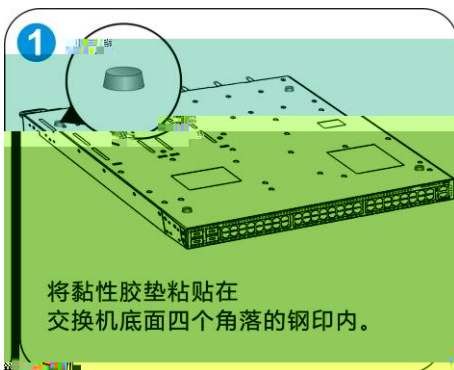

1)

2)

3)

3-4



1)

2)

3)

3-5

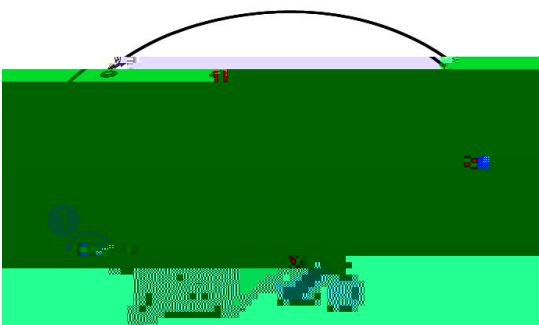

M6220-FAN-F

M6220

1) RG-S6220

2)

3)

3-6

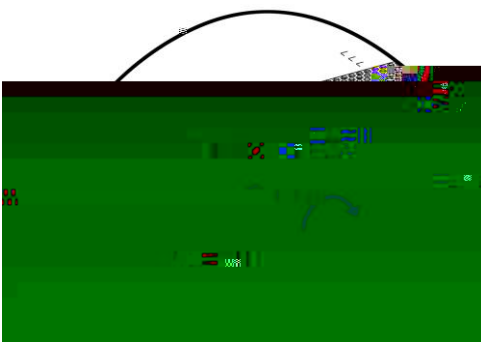
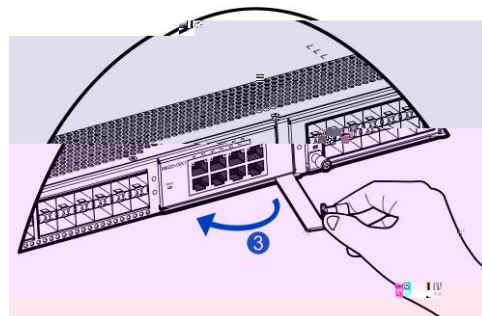
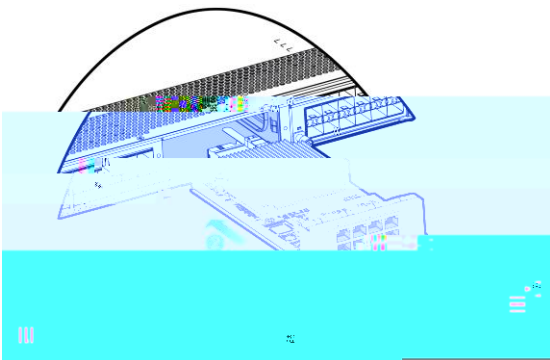

- 1) RJ45
 - 2)
 - 3)
 - 4)
- 3-7

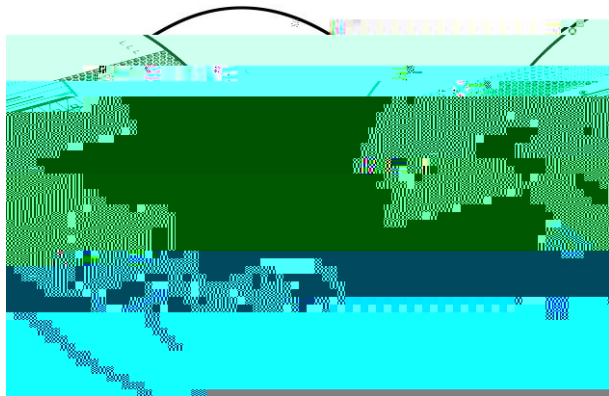
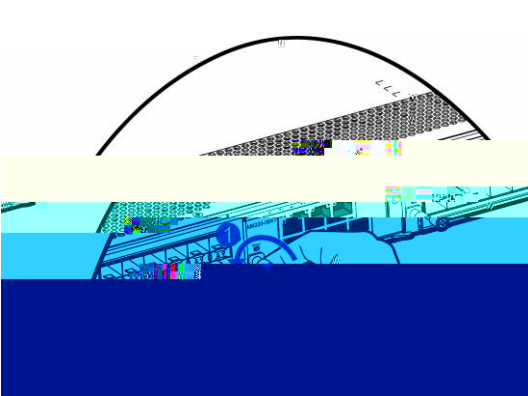

M6220

- 1)
- 2)

3-8

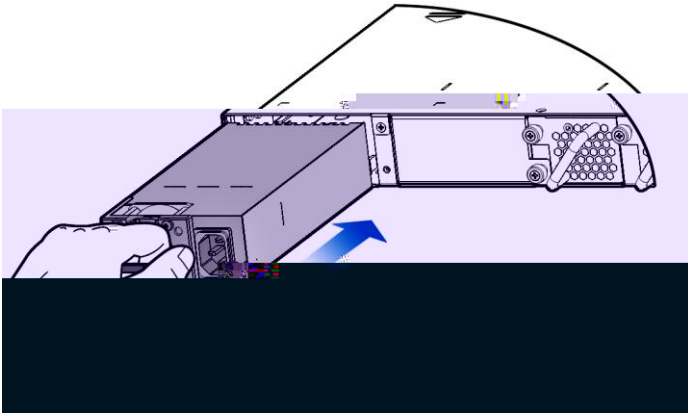

1)

2)

3-9

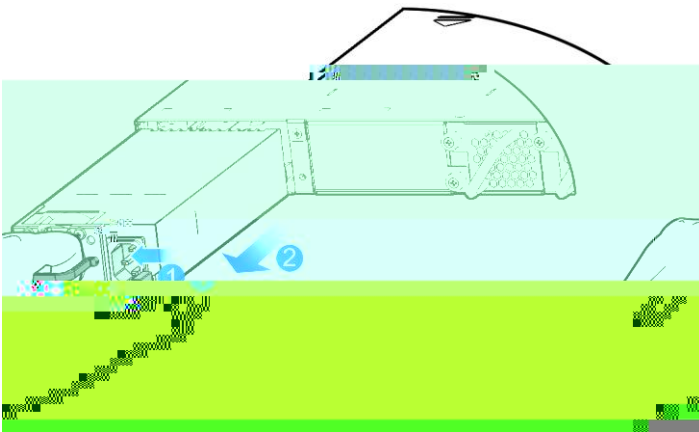

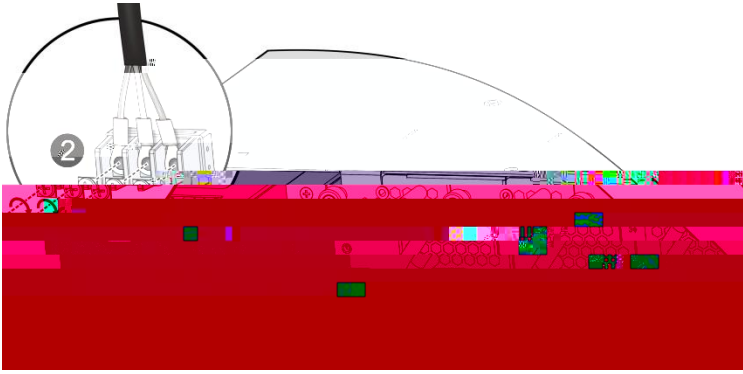

3-11

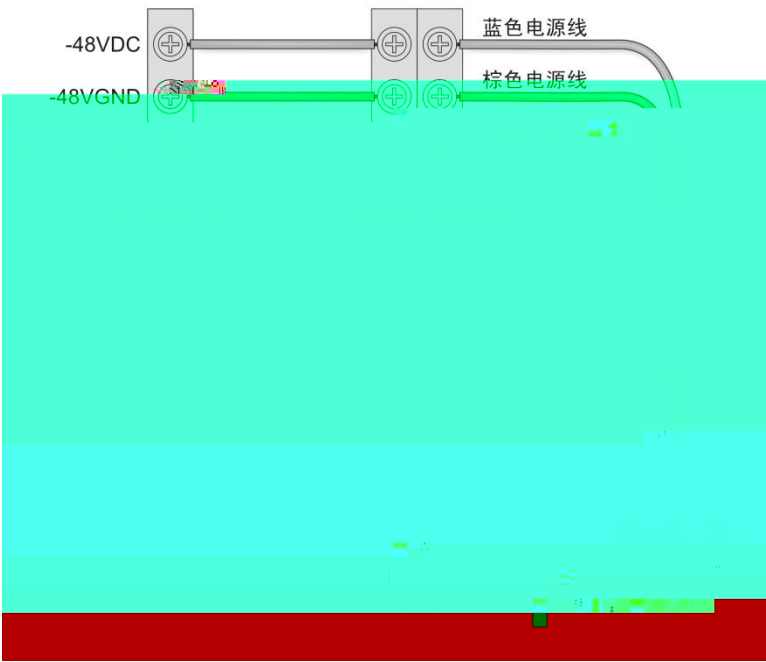

1

2

" "

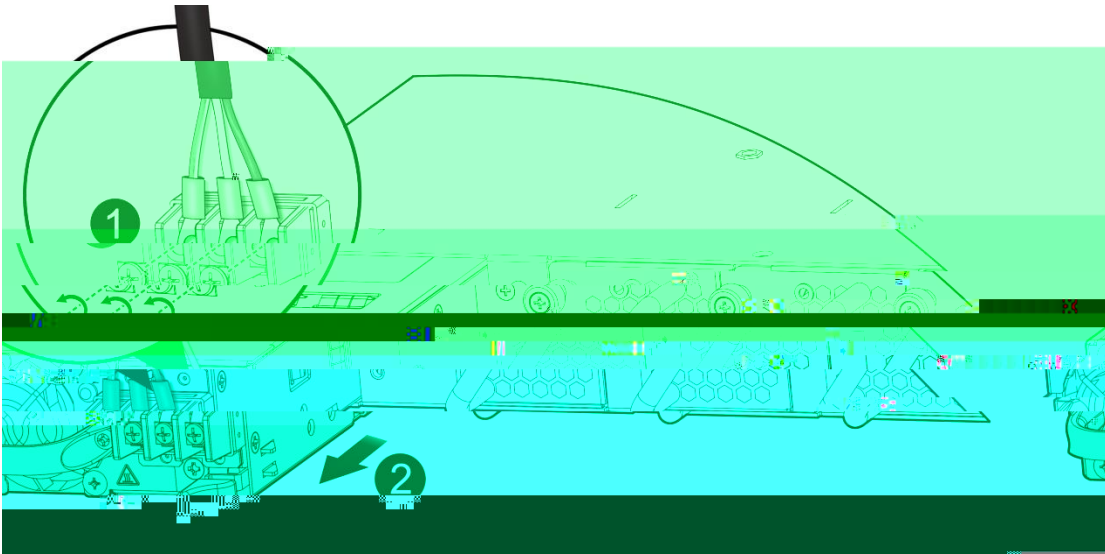

1

2

(3-12)

3

RG-M6220-DC460E-F

RG-S6220

-
-
-

1

1

2.5

12AWG

RJ-45

Console

DB9

9600

8

1

■

■

1)

RJ45

RCMI

2)

,

3)

RJ45

■

■

■

1)

2)

3)

.....

-
-
-
-
-

20

-
-
-
-

-

PC Console 4-1
4-1

- 1) DB-9 PC
- 2) RJ45 Console

■ PC PC Windows3.1 Terminal Windows 95/98/NT/2000/XP

■ 9600 8 1

- 1) “ ”_“ ”_“ ”_“ ”_“ ” 4-2

4-2

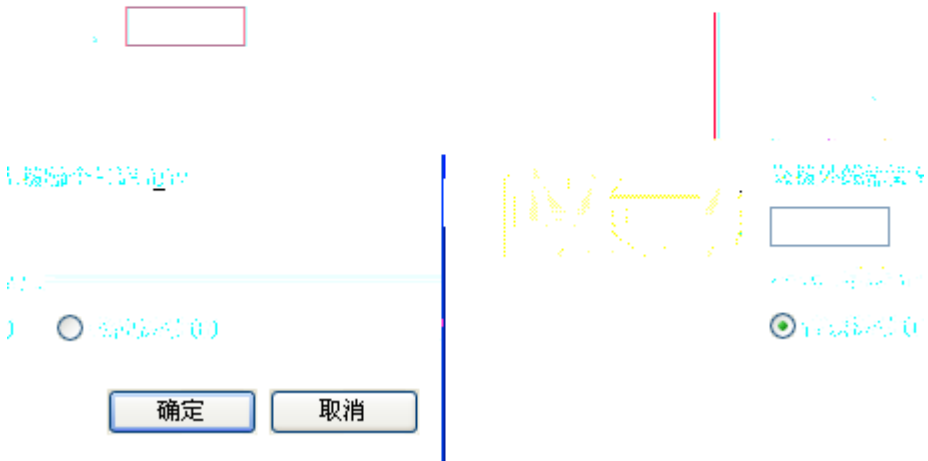
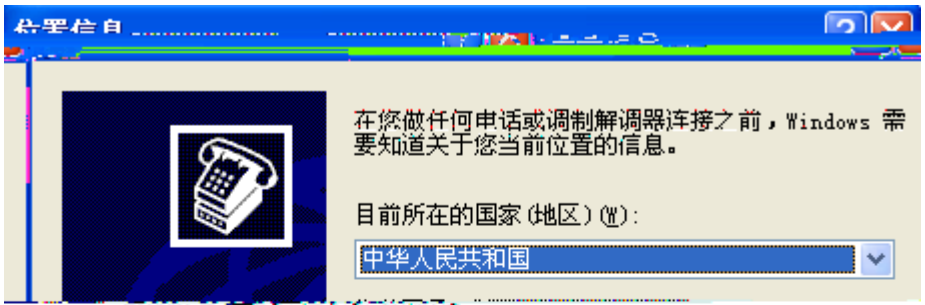

2) “ ” 4-3
4-3



3) < > 4-4
4-4

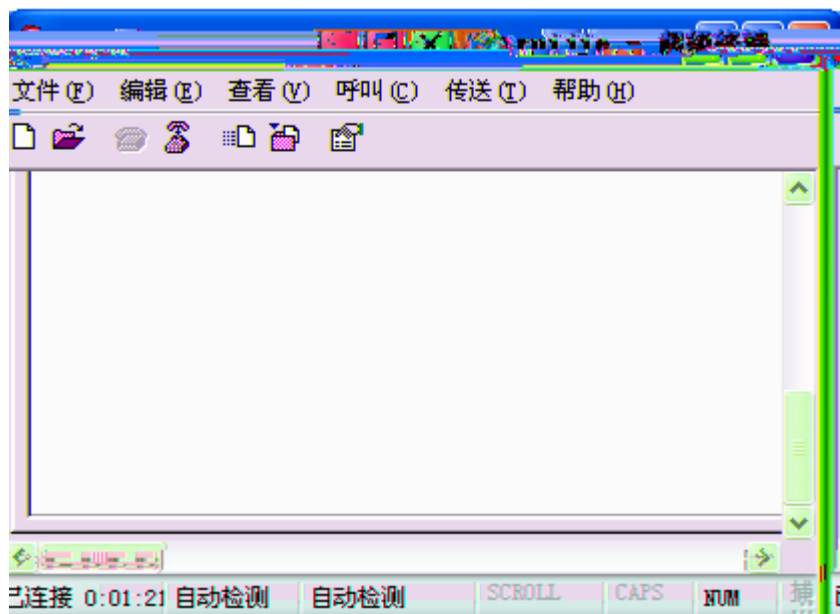

-
-
-
-
-
-
-
-

PC

RG-S6220

■

■

RG-S6220

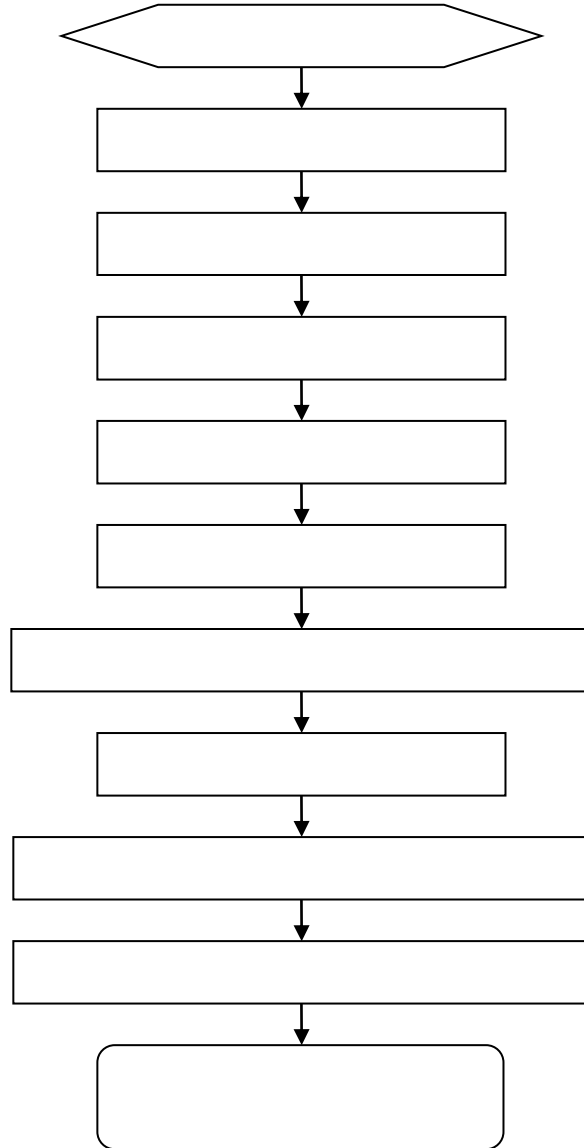

Status

Status

link

1

2

1310nm

10GBASE-T/1000BASE-T/100BASE-TX

MDI/MDIX

Crossover

10GBASE-T

IEEE 802.3an

10GBASE-T

4

4

10GBASE-T



QSFP+	FC	SFP	Mini-GBIC	SFP+	40G
SFP+	40G QSFP+	FC		Mini-GBIC	SFP
				Mini-GBIC	FC

	(nm)		(μm)	(MHz- km)		(dbm)		(dbm)	
						min	max	min	max

	(nm)		(um)	(MHz- km)		(dBm)		(dBm)		DDM (Yes/No)
						min	max	min	max	
FC2G-SFP-SR-MM850	850	(LC)	62.5/125	N/A	300m(1G) 150m(2G)	-9	-3	-18	0	YES
			50/125	N/A	550m(1G) 300m(2G)					
FC4G-SFP-SR-MM850	850	(LC)	62.5/125	N/A	300m(1G) 150m(2G) 70m(4G)	-9	-2.5	-15	0	YES
			50/125	N/A	550m(1G) 300m(2G) 150m(4G)					
FC8G-SFP-SR-MM850	850	(LC)	50/125	N/A	300m(2G) 150m(4G) 50m(8G)	-8.2	-3	-18	0	YES
			50/125	OM3	500m(2G) 380m(4G) 150m(8G)					

C-1

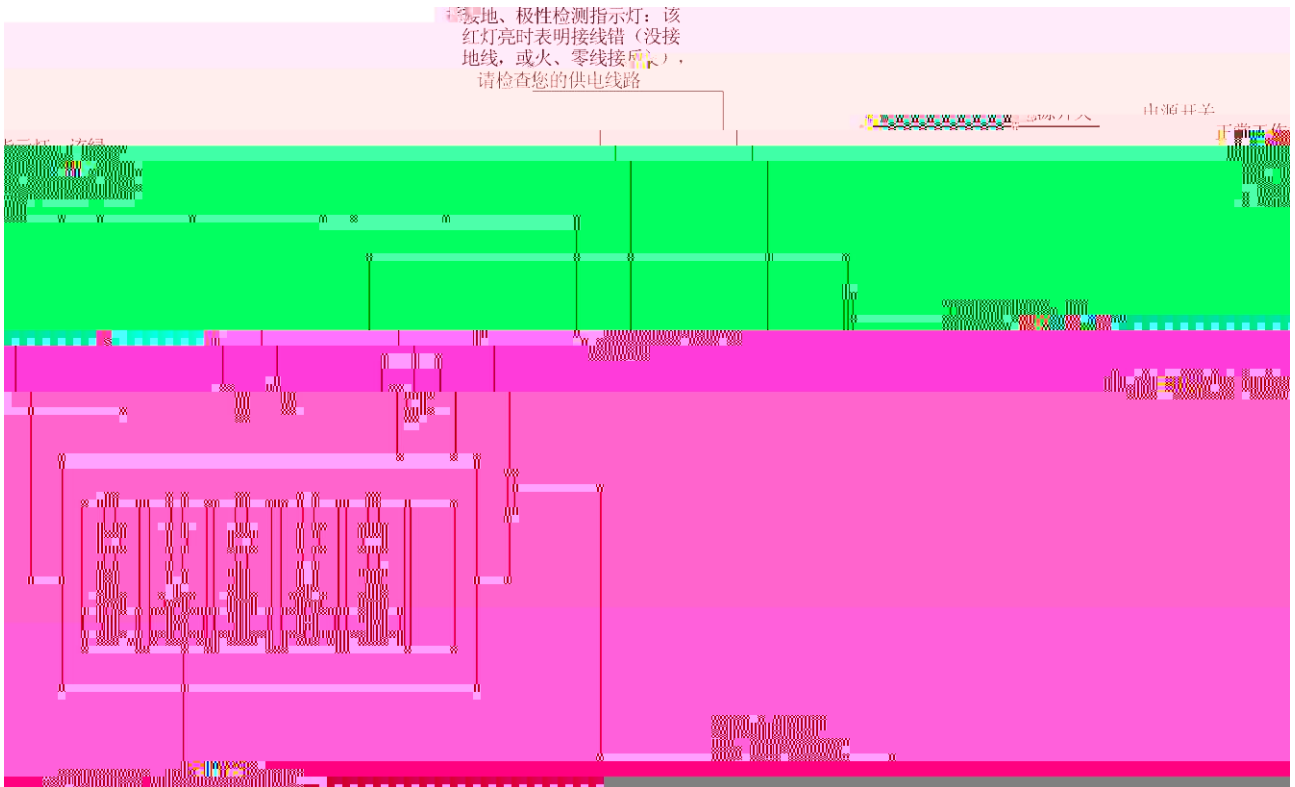

-
-
-

PE

PE

PE



■

30mm

■

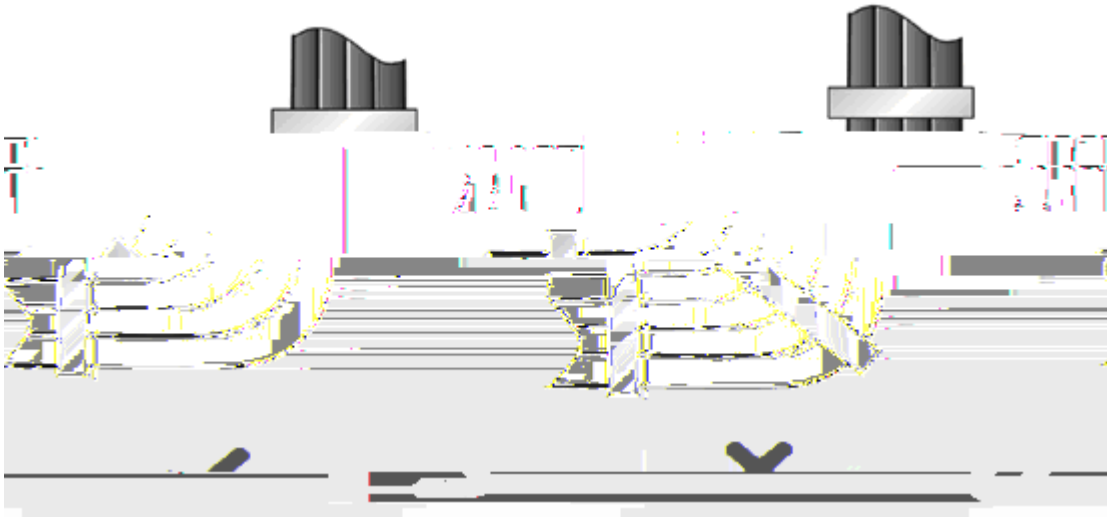

-
-
-

- 3.7km 5km 2km
- 3.7km
-
-
-
-
-
-
- 600mm
-
-
-
-
-