



RG-S2900

RGOS 10.4(2)

©2010



RGOS® 10.4(2)

1.

Courier New

5

2.

Arial

```
[]      []
```

```
{x|y|...}
```

```
[x|y|...]
```

```
//
```

3.

1.

2.

3.

1 CLI

1.1

1.1.1 alias

alias

no

alias *mode command-alias original-command*

no alias *mode [original-command]*

<i>mode</i>	
<i>command-alias</i>	
<i>original-command</i>	

EXEC

EXEC

h p s u un

help ping show

undebug undebug

no alias exec

```
Ruijie# s?
*s=show show start-chat start-terminal-service
```

EXEC

"sv" "show version"

```
Ruijie# s?
*s=show *sv="show version" show start-chat
start-terminal-service
```

```
Ruijie# s?
show start-chat start-terminal-service
```

"ia"

"ip address"

```
Ruijie(config-if)# ia ?
A.B.C.D IP address
dhcp IP Address via DHCP
Ruijie(config-if)# ip address
```

"ip address"

show aliases

"def-route"

"ip route"

0.0.0.0 0.0.0.0 192.168.1.1"

```
Ruijie# configure terminal
Ruijie(config)# alias config def-route ip route 0.0.0.0 0.0.0.0
192.168.1.1
Ruijie(config)# def-route?
*def-route="ip route 0.0.0.0 0.0.0.0 192.168.1.1"
Ruijie(config)# def-route?
% Unrecognized command.
Ruijie(config)# end
Ruijie# show aliases config
globe configure mode alias:
def-route ip route 0.0.0.0 0.0.0.0 192.168.1.1
```

show aliases	

privilege

ommand-string

mand-string

CLI

0-15

CLI

privilege ?

0.0.2 294.68 -139.2 -19.1Hp

```

Ruijie(config)# enable secret level 1 0 test
Ruijie(config)# privilege exec level 1 reload
                1    CLI                reload
Ruijie> reload ?
<cr>
                reload                1                all
Ruijie(config)# privilege exec all level 1 reload
                1    CLI                reload
Ruijie> reload ?
at                reload at a specific time/date
cancel            cancel pending reload scheme
in                reload after a time interval
<cr>
    
```

enable secret	CLI



EXEC

```
Ruijie# show aliases exec
```

```
exec mode alias:
```

```
h             help  
p             ping  
s             show  
u             undebug  
un           undebug
```



2

2.1

2.1.1 disable

disable

disable [*privilege-level*]

	<i>privilege-level</i>	

|

|

|

disable

Ruijie# **disable 10**

	enable	

	-	-

2.1.2 enable

enable

	-	-

--	--

--	--

--	--

--	--

	-	-

--	--

	-	-

2.1.3 enable password

enable password

no

enable password [*level level*] {*password* | [0 | 7] *encrypted-password*}**no enable password**

<i>Password</i>	EXEC	
<i>Level</i>		
0 7	0	7
<i>encrypted-password</i>		

1 26

EXEC

pw10

Ruijie(config)# **enable password** pw10

enable secret	

-	-

2.1.4 enable secret

enable secret

no

enable secret [*level level*] {*secret* | [0 | 5] *encrypted-secret*}

no enable secret

<i>Secret</i>	EXEC
<i>Level</i>	
0 5	0 5
<i>encrypted-password</i>	

|

|

|

|

no enable service

enable service ssh-sesrver, SSH Server

Ruijie(Config # **enable service ssh-sesrver**



Telnet

configure terminal

line tty 1 16

enable

Web

no ip http authentication

Web

local

Ruijie(config)# **ip http authentication local**

enable service

EXEC

lock

lock

-	-

lock

" Locked"

line

lockable

line

```
Ruijie(config-line)# lockable
Ruijie(config-line)# end
Ruijie# lock
Password: <password>
Again: <password>
Locked
Password: <password>
```

lockable	

-	-

2.1.11 lockable

lockable lock line lockable
 lock no

-	-

┌

┌ line

┌ lock

EXEC

Ruijie(config)# **line console 0**
 Ruijie(config-line)# **lockable**
 Ruijie(config-line)# **end**
 Ruijie# **lock**
 Password: <password>
 Again: <password>
 Locked
 Password: <password>

lock	

login

no login

	-	-

|

|

line

|

AAA
VTY console

|

VTY
Ruijie(config)# **no aaa new-model**
Ruijie(config)# **line vty 0**
Ruijie(config-line)# **password 0 normatest**
Ruijie(config-line)# **login**

|

--	--

password

line

-

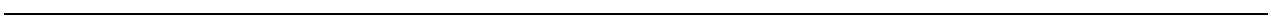

line

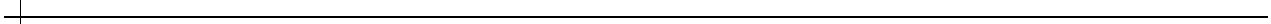
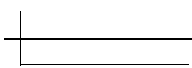

username

VTY

Ruijie(config)# **no aaa new-model**

Ruijie(config)# **username test password 0 test**

Ruijie(config)# **line vty 0**

Ruijie(config-line)# **login local**

username	

-	-

2.1.15 privilege mode

CLI

-	-

CLI

CLI

CLI

CLI

-	-

--	--

	-	-
--	---	---

2.1.16 password

line line **password** **no** line

password {*password* | [0-7] *encrypted-password*}

no password

<i>password</i>		line

service password-encryption

--	--

interface <i>interface-name</i>	Telnet
!vrf <i>vrf-name</i>	VRF

┌

┌

┌

telnet	
/ipv6	IPV6

┌

```

1          telnet          IPV4      192.168.1.1
          vlan 1          VRF          vpn1
Ruijie# telnet 192.168.1.1 /source interface vlan 1 /vrf vpn1
2          telnet          IPV6      2AAA:BBBB::CCCC
Ruijie# telnet 2AAA:BBBB::CCCC

```

┌

ip telnet source-interface	IP Telnet
show session	TTY
exit	

┌

┌

-	-

2.1.19 username

<i>password</i>	
07	0 7
<i>encrypted-password</i>	
<i>privilege-level</i>	

	<i>message</i>	
	Ruijie(config) Ruijie(config)# banner login \$ <i>enter your password</i> \$	
	-	-
	-	-

2.2.2 banner motd

	no banner motd	banner motd
	banner motd <i>c message c</i>	
	<i>c</i>	
	<i>message</i>	

```

Ruijie#show boot system
system boot file: flash:/rgos.bin

Ruijie#dir
Directory of flash:/
  11015744 2008-01-01 08:00:46  rgos.bin
  12019754 2008-02-01 08:00:46  s5750_10_4.bin
    399 2006-01-01 08:01:37  config.text
33,030,144 bytes total. (10,590,592 bytes free)

Ruijie(config)# boot system s5750_10_4.bin
Ruijie(config)# show boot system
system boot file: flash:/ s5750_10_4.bin
                        s5750_10_4.bin

```

show boot system	

-

-	-

2.2.4 clock set

clock set

clock set *hh:mm:ss month day year*

<i>hh:mm:ss</i>	24 : :
<i>day</i>	1-31
<i>month</i>	1-12
<i>year</i>	1993-2035

|

|

|

clock set

|

2003 3 17 10 20 30

Ruijie# **clock set** 10:20:30 3 17 2003

Ruijie# **show clock**

clock: 2003-3-17 10:20:32

|

show clock	

|

|

-	-

2.2.5 clock update-calendar

clock update-calendar

|

-	-

|

|

|

calendar

```
Ruijie# clock update-calendar
```



L

--	--

-

- ÎB1u)ÓÞÛ

AGÀ´



|

|

|

|

```
10
Ruijie# reload in 10
Router will reload in 600 seconds.
```

|

-	-

|

|

-	-

2.2.10 session-timeout

```
LINE session-timeout
no session-timeout LINE
session-timeout minutes [output]
no session-timeout
```

|

minutes	
output	

|

```
0 min
```

|

```
LINE
```

|

```
LINE
LINE
```

|

```
line vty 0 5 30
```

```
Ruijie(config-line)# exec-timeout 5 30
```

-	-

-	-

2.2.11 speed

speed speed

no speed

speed speed

<i>Speed</i>	bps 9600 19200 38400 57600 115200 9600

9600

57600 bps

```
Ruijie(config)# line console 0
```

```
Ruijie(config-line)# speed 57600
```

-	-

--	--

```

[Failed]
The device [usb1] does not exist, write to the default config file
[/config.text]? [no] yes
Write to the default config file: [/config.text]
[OK]

```

boot config	
copy	
show running-config	

-	-

2.3

2.3.1 show clock

show clock

show clock

-	-

detail

show clock

```

Ruijie# show clock
clock: 2003-3-17 10:27:21

```

clock set	

-	-

2.3.2 show line

show line

show line [*console line-num* | *aux line-num* | *vty line-num* | *line-num*]

console	
aux	aux
vty	vty
<i>line-num</i>	line

```

                console
Ruijie# show line console 0
CON   Type   speed  Overruns
* 0   CON    9600   45927
Line 0, Location: "", Type: "vt100"
Length: 24 lines, Width: 79 columns
Special Chars: Escape Disconnect Activation
                ^^x   none   ^M
Timeouts:      Idle EXEC   Idle Session
                never   never
History is enabled, history size is 10.

```

```
Total input: 53564 bytes
Total output: 395756 bytes
Data overflow: 27697 bytes
stop rx interrupt: 0 times
```

-	-

-	-

2.3.3 show reload

show reload

show reload

-	-

```
Ruijie# show reload
Reload scheduled in 595 seconds.
At 2003-12-29 11:37:42
Reload reason: test.
```

-	-

	-	-

2.3.4 show running-config

show running-config

show running-config

	-	-

|

|

|

|



	-	-

|

--	--

L

By Ruijie Network

System start time: 1970-6-14 11:49:53

System uptime: 3:17:1:17

System hardware version: 2.0

System software version: RGOS 10.3.00(4), Release(34679)

System boot version: 10.2.34077

System CTRL version: 10.2.24136

System serial number: 1234942570001

-	-

-	-

3 LINE

3.1 LINE

3.1.1 access-class

Line ACL **access-class** *acl-no* { **in** | **out** }
Line no **access-class** *access-list-number* { **in** | **out** }
LINE ACL
[no] **access-class** *access-list-number* { **in** | **out** }

LINE

	-	-

3.1.2 line

LINE

line [**aux** | **console** | **tty** | **vty**] *first-line* [*last-line*]

aux		
console		
tty		
vty		telnet/ssh
<i>First-line</i>		first-line
<i>Last-line</i>		last-line

|

|

|

LINE

|

```
LINE VTY 1 3 LINE
Ruijie(config)# line vty 1 3
```

|

	-	-

|

|

	-	-

3.1.3 line vty

VTY VTY no
line vty *line-number*
no line vty *line-number*

-	-

VTY 5 0-4

VTY

1 VTY 20 VTY 0-19
 Ruijie(config)# **line vty** 19
 2 VTY 10 VTY 0-9
 Ruijie(config)# **line vty** 10

-	-

-	-

3.1.4 transport input

Line **transport input** Line
default transport input LINE

transport input {all | ssh | telnet | none}

default transport input

all	Line
ssh	Line SSH

LINE

telnet	Line	Telnet
none	Line	

VTY TTY NONE
default transport input

Line

Line VTY VTY **show**
running Line
input default transport input no transport
transport input none

```

line vty 0 4 telnet
Ruijie# configure terminal
Ruijie(config)# line vty 0 4
Ruijie(config-line)# transport input telnet

```

show running	
---------------------	--

RGOS10.1

-	-
---	---

4

4.1

4.1.1 ping

ping [*vrf vrf-name*] [*ip*] [*ip-address* [*length length*]] [*ntimes times*] [*timeout seconds*] [*data data*] [*source source*] [*df-bit*] [*validate*]



DNS

1 ping

```
Ruijie# ping 192.168.5.1
```

```
Sending 5, 100-byte ICMP Echoes to 192.168.5.1, timeout is 2 seconds:
```

```
< press Ctrl+C to break >
```

```
!!!!
```

```
Success rate is 100 percent (5/5), round-trip min/avg/max = 1/2/10  
ms
```

2 ping

```
Ruijie# ping 192.168.5.197 length 1500 ntimes 100 timeout 3 data ffff  
source 192.168.4.10
```

```
Sending 100, 1000-byte ICMP Echoes to 192.168.5.197, timeout is 3  
seconds:
```

```
< press Ctrl+C to break >
```

```
!!!!!!!!!!!!!!!!!!!!!!!!!!!!!!!!!!!!!!!!!!!!!!!!!!!!!!!!!!!!!!!!!!!!  
!!!!!!!!!!!!!!!!!!!!!!!!!!!!!!!!!!!!!!!!!!!!!!!!!!!!!!!!!!!!!!!!!!!!
```

```
Success rate is 100 percent (100/100), round-trip min/avg/max = 2/2/3  
ms
```

-	-

-	-

4.1.2 ping ipv6

```
ping [ipv6] [ip-address [length length ] [ntimes times] [timeout seconds] [data data]  
[source source]]
```

ip-address	IPv6

<i>length</i>	
<i>times</i>	
<i>seconds</i>	
<i>data</i>	
<i>source</i>	IPv6 ::1

2 5 100Byte IP

```

Ping ipv6
  ping ipv6
  ping ipv6
    2            5            100Byte            IP
    '!'                    ':'
      'C'
      ping
ping ipv6
  
```

	-	-
	ipv6	
	-	-

4.1.3 traceroute

traceroute

traceroute [**vrf**] [*vrf-name*] [**ip** *ip-address*][*ip-address* [**probe** *number*] [**source** *source*]
[**timeout** *seconds*] [**ttl** *minimum maximum*]

<i>vrf-name</i>	VRF
<i>ip-address</i>	IPv4
<i>number</i>	
<i>source</i>	IPv4 127.0.0.1
<i>seconds</i>	
<i>minimum maximum</i>	

```

2      192.168.9.2      4 msec  4 msec  4 msec
3      192.168.9.1      8 msec  8 msec  4 msec
4      192.168.0.10     4 msec  28 msec 12 msec
5      202.101.143.130  4 msec  16 msec  8 msec
6      202.101.143.154 12 msec  8 msec  24 msec
7      61.154.22.36    12 msec  8 msec  22 msec
                                     IP      61.154.22.36
1 6

```

2 traceroute

```

Ruijie# traceroute 202.108.37.42
< press Ctrl+C to break >
Tracing the route to 202.108.37.42
1      192.168.12.1     0 msec  0 msec  0 msec
2      192.168.9.2      0 msec  4 msec  4 msec
3      192.168.110.1   16 msec 12 msec 16 msec
4      * * *
5      61.154.8.129    12 msec 28 msec 12 msec
6      61.154.8.17     8 msec 12 msec 16 msec
7      61.154.8.250    12 msec 12 msec 12 msec
8      218.85.157.222 12 msec 12 msec 12 msec
9      218.85.157.130 16 msec 16 msec 16 msec
10     218.85.157.77   16 msec 48 msec 16 msec
11     202.97.40.65    76 msec 24 msec 24 msec
12     202.97.37.65    32 msec 24 msec 24 msec
13     202.97.38.162   52 msec 52 msec 224 msec
14     202.96.12.38    84 msec 52 msec 52 msec
15     202.106.192.226 88 msec 52 msec 52 msec
16     202.106.192.174 52 msec 52 msec 88 msec
17     210.74.176.158 100 msec 52 msec 84 msec
18     202.108.37.42   48 msec 48 msec 52 msec
                                     IP      202.108.37.42
1 17 4

```

```

Ruijie# traceroute www.ietf.org
Translating " www.ietf.org "...[OK]
< press Ctrl+C to break >
Tracing the route to 64.170.98.32
1      192.168.217.1    0 msec  0 msec  0 msec
2      10.10.25.1       0 msec  0 msec  0 msec

```

```

3      10.10.24.1      0 msec  0 msec  0 msec
4      10.10.30.1     10 msec  0 msec  0 msec
5      218.5.3.254   0 msec  0 msec  0 msec
6      61.154.8.49   10 msec  0 msec  0 msec
7      202.109.204.210 0 msec  0 msec  0 msec
8      202.97.41.69  20 msec  10 msec  20 msec
9      202.97.34.65  40 msec  40 msec  50 msec
10     202.97.57.222  50 msec  40 msec  40 msec
11     219.141.130.122 40 msec  50 msec  40 msec
12     219.142.11.10  40 msec  50 msec  30 msec
13     211.157.37.14  50 msec  40 msec  50 msec
14     222.35.65.1    40 msec  50 msec  40 msec
15     222.35.65.18  40 msec  40 msec  40 msec
16     222.35.15.109  50 msec  50 msec  50 msec
17     *      *      *
18     64.170.98.32  40 msec  40 msec  40 msec

```

-	-

-

-	-

4.1.4 traceroute ipv6

traceroute ipv6

traceroute [ipv6 ip-address] [probe number] [timeout seconds] [ttl minimum maximum]

<i>ip-address</i>	IPv6
<i>number</i>	
<i>seconds</i>	
<i>minimum maximum</i>	TTL

Traceroute ipv6

DNS

traceroute ipv6

1 traceroute ipv6

Ruijie# **traceroute ipv6 3004::1**

< press Ctrl+C to break >

Tracing the route to 3004::1

1	3000::1	0 msec	0 msec	0 msec
2	3001::1	4 msec	4 msec	4 msec
3	3002::1	8 msec	8 msec	4 msec
4	3004::1	4 msec	28 msec	12 msec

IP 3004::1

1 4

2 traceroute ipv6

Ruijie# **traceroute ipv6 3004::1**

< press Ctrl+C to break >

Tracing the route to 3004::1

1	3000::1	0 msec	0 msec	0 msec
2	3001::1	4 msec	4 msec	4 msec
3	3002::1	8 msec	8 msec	4 msec
4	* * *			
5	3004::1	4 msec	28 msec	12 msec

IP 3004::1

1 5 4

-	-

--	--	--

- -

5

5.1

5.1.1 carrier-delay

carrier-delay

no

carrier-delay [*seconds*]

no carrier-delay

<i>seconds</i>		1 60

2

DCD DCD Down Up
DCD
DCD DCD

	-	-
--	---	---

5.1.2 clear counters

clear counters [*interface-id*]

	<i>interface-id</i>	

|

|

	show interfaces	clear
counters		

Ruijie# **clear counters gigabitethernet 1/1**

	show interfaces	

|

	-	-

5.1.3 clear interface

clear interface *interface-id*

	<i>interface-id</i>	

|

┌

┌

Switch Port,L2 Aggregate port ,Routed port,L3 Aggregate port
shutdown no shutdown

┌

Ruijie# **clear interface gigabitethernet 1/1**

┌

shutdown	

┌

┌

-	-

5.1.4 description

no

description *string*

no description

┌

<i>string</i>	

┌

┌

┌

show interfaces

┌

Ruijie(config)# **interface gigabitethernet 1/1**
Ruijie(config-if)# **description GBIC-1**

┌

show interfaces	

	-	-

5.1.5 duplex

no

duplex {auto | full | half}

no duplex

	auto	
	full	
	half	

|

|

|

show interfaces

|

Ruijie(config-if)# **duplex full**

--	--	--

no

flowcontrol {auto | off | on}

no flowcontrol

auto	
off	
on	

└───┘

└───┘

└───┘

show interfaces

└───┘

1/1

Ruijie(config)# **interface gigabitethernet 1/1**

Ruijie(config-if)# **flowcontrol on**

show interfaces	

└───┘

-	-

5.1.7 interface aggregateport

no

interface aggregateport *port-number*

<i>port-number</i>	Aggregate port

└───┘

|

|

show aggregate Ä aggregate interfaces show
interfaces

|

Ruijie(config)# interface aggregateport 3
Ruijie(config-if)#

|

Q,	£EÄ

|

S2900

|

	AÈ á

|

interface	mod-num/port-num	fastEthernet
- D		£EÄ
mod-num/port-num	/	

|

|

|

no show show
fastEthernet

|

Ruijie(config)# interface fastEthernet 1/2
Ruijie(config-if)#

	show interfaces	
	S2900	
	-	-

5.1.9 interface giagbitEthernet

interface gigabitEthernet *mod-num/port-num*

	<i>mod-num/port-num</i>	/

no

show interfaces **show interfaces**

gigabitEthernet

Ruijie(config)#
Ruijie(config-if)#

interface gigabitEthernet 1/2



5.1.10 interface vlan

switch virtual interface SVI noce

```

Ruijie(config)#interface gigabitEthernet 0/1
Ruijie(config-if-GigabitEthernet 0/1)#line-detect
Interface : GigabitEthernet 0/1
start cable-diagnoses,please wait...
cable-daignoses end!this is result:
4 pairs
pair state      length(meters)
-----
A   Ok          1
pair state      length(meters)
-----
B   Ok          2
pair state      length(meters)
-----
C   Short       1
pair state      length(meters)
-----
D   Short       1

```

pairs											
state	Short		A B C D				OK		Short OK C D		Open
length			Short		Open		state OK		length		

-	-

5.1.12 medium-type

no

medium-type { fiber | copper }

no medium-type

fiber	
copper	

|

|

Ap SVI

|

```
Ruijie(config)# interface gigabitethernet 1/1  
Ruijie(config-if)# medium-type copper
```

show interfaces	

|

```
24SFP/12GT      12  SFP      12  10/100/1000M BASE-T  
                SFP      10/100/1000M BASE-T
```

-	-

5.1.13 mtu

mtu

Mtu num

<i>num</i>	64 9216(65536)

|

1500

|

mtu

Ruijie(config)# **interface gigabitethernet 1/1**
Ruijie(config-if)# **mtu 9216**

show interfaces	

-	-

5.1.14 shutdown

no

shutdown

no shutdown

-	-

Ap SVI

show interfaces

no shutdown

1 Ap 1

Ruijie(config)# **interface aggregateport 1**

Ruijie(config-if)# **shutdown**

2 Ap 1

Ruijie(config)# **interface aggregateport 1**

Ruijie(config-if)# **no shutdown**

--	--

clear interface

show interfaces

Ruijie(config-if)# snmp trap link-status	link trap
Ruijie(config-if)# no snmp trap link-status	link trap

-	-

5.1.16 speed

no

10	10Mbps
100	100Mbps
1000	1000Mbps
10G	10Gbps
auto	

Ap

Ap

Ap

show interfaces
SFP

È



switchport trunk {allowed vlan {all | [add | remove | except] vlan-list }| native vlan vlan-id}

no switchport trunk {allowed vlan | native vlan}

	Trunk	VLAN	vlan-list
	VLAN		VLAN
	VLAN ID	VLAN ID	-
	10-20		,
	1-10,20-25,30,33		
allowed vlan <i>vlan-list</i>	all	VLAN	VLAN
	add	VLAN	VLAN
	remove	VLAN	VLAN
	except	VLAN	VLAN
	VLAN		
native vlan <i>vlan-id</i>	Native VLAN		

	VLAN	all	Native VLAN	VLAN 1
--	------	-----	-------------	--------

```

Access vlan is 1,Native vlan is 1
Protected is disabled
Vlan lists is
1,3-4094

```

show interfaces	
switchport access	accessport statics VLAN

-	-

5.2

5.2.1 show interfaces

show interfaces [*interface-id*] [**counters** | **description** | **status** | **switchport** | **trunk** | **transceiver** [**alarm** | **diagnosis**]]

<i>interface-id</i>	loopback aggregateport SVI
counters	
description	link
status	
switchport	
trunk	trunking port Aggregate port
transceiver	
alarm	" None"

diagnosis	
------------------	--

S2900

```
Ruijie# show interfacesgigabitEthernet 0/1 switchport
Interface Switchport ModeAccess Native Protected VLAN lists
-----
GigabitEthernet 0/1 enabled Access 11 Disabled ALL
```

duplex	
flowcontrol	
interface gigabitEthernet	
interface aggregateport	

interface vlan

switch virtual interface

8

6 Aggregate Port

6.1

6.1.1 aggregateport load-balance

AP no

aggregateport load-balance {dst-mac | src-mac | src-dst-mac | dst-ip | src-ip | src-dst-ip }

no aggregateport load-balance

dst-mac	MAC	MAC	AP
src-mac	MAC	MAC	AP
src-dst-ip	IP	IP	IP— IP—
dst-ip	IP	IP	AP
src-ip	IP	IP	AP
src-dst-mac	MAC—	MAC—	

MAC

Aggregate Port

S2900		
	31	8 AP
	-	-

6.2

6.2.1 show aggregateport

aggregateport

<i>aggregate-port-number</i>	Aggregate Port

Aggregate Port

7 VLAN

7.1

7.1.1 name

VLAN **no**

name *vlan-name*

no name

	<i>vlan-name</i>	VLAN

VLAN	VLAN	VLAN ID	VLAN 2	"VLAN0002"
------	------	---------	--------	------------

VLAN		
------	--	--

show vlan	vlan	
------------------	------	--

```
Ruijie(config)# vlan 10
Ruijie(config-vlan)# name vlan10
```

show vlan		VLAN

--	--	--

	-	-

7.1.2 switchport access

no access port VLAN VLAN

switchport access vlan *vlan-id*

no switchport access vlan

access	switch port	access port
trunk	switch port	trunk port
hybrid	switch port	hybrid port

no switchport trunk {allowed vlan | native vlan }

allowed vlan <i>vlan-list</i>		Trunk	VLAN	vlan-list
		VLAN		VLAN
		VLAN ID	VLAN ID	-
		10-20		,
		1-10,20-25,30,33		
		all	VLAN	VLAN
	add	VLAN	VLAN	
	remove	VLAN	VLAN	
	except	VLAN	VLAN	
		VLAN		
native vlan <i>vlan-id</i>		Native VLAN		

VLAN all Native VLAN VLAN 1

Native VLAN

Trunk native VLAN native VLAN
 UNTAG VLAN VLAN ID
 IEEE 802.1Q PVID native VLAN VLAN ID Trunk
 native VLAN UNTAG
VLAN
 Trunk VLAN 1 4094
 Trunk VLAN VLAN Trunk

show interfaces switchport

```

VLAN 2 1/15
Ruijie(config)# interface fastethernet 1/15
Ruijie(config-if)# switchport trunk allowed vlan remove 2
Ruijie(config-if)# end
Ruijie# show interfaces fastethernet1/15 switchport
Interface Switchport Mode Access Native Protected VLAN lists
-----
FigabitEthernet 1/15 enabled TRUNK 1 1 Disabled 1,3-4094
    
```

--	--	--

VLAN

-	-
---	---

7.2

7.2.1 show vlan

VLAN

show vlan [id *vlan-id*]

<i>vlan-id</i>	VLAN ID
----------------	---------

┌

┌

┌
end **Ctrl+C**
exit

```
Ruijie# show vlan id 1
VLAN Name                Status    Ports
-----
 1 VLAN0001                STATIC    Fa0/1, Fa0/2
```

name	VLAN
switchport access	Vlan

┌

-	-
---	---

┌
└
┌
└
┌
└
┌
└

```
Ruijie(config)# protocol-vlan profile 1 frame-type ETHERII
ether-type aarp
```

show protocol-vlan profile	-
show protocol-vlan profile <i>num</i>	-
no protocol-vlan profile	-
no protocol-vlan profile <i>num</i>	-

┌
└
┌
└

RGOS10.1

-	-

8.1.3 protocol-vlan profile num vlan id

profile

┌
└
┌
└
┌
└
┌
└

<i>num</i>	profile
<i>id</i>	VLAN ID 1- VLAN

```
Ruijie(config-if)# protocol-vlan profile 1 vlan 101
```

show protocol-vlan profile	-
show protocol-vlan profile <i>num</i>	-
no protocol-vlan profile	-
no protocol-vlan profile <i>num</i>	-

RGOS10.1



Protocol VLAN

	-	-
--	---	---

9 Private VLAN

9.1

9.1.1 private-vlan association

secondary VLAN primary VLAN

private-vlan association {*svlist* | **add** *svlist* | **remove** *svlist*}

no private-vlan association

private-vlan mapping {*svlist* | **add** *svlist* | **remove** *svlist*}

no private-vlan mapping

<i>svlist</i>	secondary VLAN list
no	

|

Primary VLAN

|

```
Ruijie(config)# interface vlan 22
Ruijie(config-if)# private-vlan mapping add 24-26
```

show vlan private-vlan	-

RGOS10.1

-	-

9.1.3 private-vlan type

VLAN VLAN

private-vlan {*community* | *isolated* | *primary*}

no private-vlan {*community* | *isolated* | *primary*}

<i>community</i>	community VLAN
<i>isolated</i>	isolated VLAN
<i>primary</i>	primary VLAN
<i>no</i>	VLAN

| VLAN

| VLAN

|

| Ruijie(config)# **vlan 22**
| Ruijie(config-vlan)# **private-vlan primary**



show vlan private-vlan	-
RGOS10.1	
-	-

9.1.5 switchport private-vlan host-association

private VLAN

primary VLAN

secondary VLAN

switchport private-vlan host-association *p_vid s_vid*

no switchport private-vlan host-association

<i>p_vid</i>	primary VID
<i>s_vid</i>	secondary VID
no	VLAN

┌

┌

┌

```
Ruijie(config)# interface gigabitEthernet 0/1
Ruijie(config-if)# switchport mode private-vlan host
Ruijie(config-if)# switchport private-vlan host-association 22 23
```

```
OS 1 1.006 T...
```

show vlan private-vlan [community | primary | isolated]

primary	primary VLAN
community	community VLAN
isolated	isolated VLAN

private VLAN

Ruijie# **show vlan private-vlan**

-	-

RGOS10.1

-	-

9.3 Hybrid

9.3.1 switchport hybrid allowed vlan

switchport hybrid allowed vlan[[add][tagged | untagged] | remove] *vlist*

no switchport hybrid allowed vlan

hybrid

no	hybrid

|

|

	-	-

9.3.3 switchport mode hybrid

10 Share VLAN

10.1

10.1.1 share

share vlan	
-	-
vlan	
share vlan	no share
	end
	exit
	Ctrl+C
Ruijie(config)#vlan 2	
Ruijie(config-vlan)#share	
-	-
-	-

10.2

10.2.1 show mac-address-table share

Status	duplicated share vlan	Status	original	Status
--------	-----------------------	--------	----------	--------

	-		-	

|

|

|

end Ctrl+C
exit

```
Ruijie# show mac-address-table share
Vlan  MAC Address      Type      Interface  Status
-----
  1    0040.4650.1e1e  DYNAMIC  Gigabit 0/1  original
  2    0040.4650.1e1e  DYNAMIC  Gigabit 0/1  duplicated
```

	-		-	

|

|

	-		-	

11 MAC

11.1

11.1.1 address-bind

ip mac

address-bind *ip-address mac-address*

no address-bind *ip-address*



/

address-bind install

no address-bind install

	-	-

|

|

|

```

fa 0/1
Ruijie(config)# address-bind uplink fa0/1
Ruijie(config)# address-bind install
    
```

	show address-bind uplink	

RGOS10.1

	-	-

11.1.3 address-bind ip-address

ip mac .

address-bind ip-address mac-address

no address-bind ip-address

	<i>ip-address</i>	IP
	<i>mac-address</i>	mac

|

MAC

┌

┌

┌

┌

┌

┌

IP MAC IP MAC IP IP
MAC IP MAC

```
ip 3.3.3.3 mac 00d0.f811.1112  
Ruijie(config)# address-bind 3.3.3.3 00d0.f811.1112
```

[Redacted]	
show address-bind	
[Redacted]	

S2900 IPv4+MAC 1K.

[Redacted]	
-	-
[Redacted]	

11.1.4 address-bind ipv6-mode

ip IP

address-bind ipv6-mode compatible

address-bind ipv6-mode loose

address-bind ipv6-mode strict

┌

[Redacted]	
-	-
[Redacted]	

	Ipv4
	IPV4+MAC
	IPV4+MAC
	IPV4+MAC

	IPV6	
	ipv6	
	IPV6	
	MAC	MAC IPV6

```

IP      192.168.5.2      00d0.f822.33aa
IPV6
Ruijie# configure t
Enter configuration commands, one per line. End with CNTL/Z.
Ruijie(config)# address-bind 00d0.f822.33aa ip 192.168.5.2
Ruijie(config)# address-bind ipv6-mode compatible
    
```

-	-

-	-

11.1.5 address-bind uplink

```

ip      mac      .
address-bind uplink intf-id
no address-bind uplink intf-id
    
```

<i>intf-id</i>	

```
Ruijie# clear mac-address-table dynamic
```

show mac-address-table dynamic	

-	-

11.1.7 clear mac-address-table filtering

clear mac-address-table filtering [**address** *mac-addr*] [**vlan** *vlan-id*]

filtering	
address <i>mac-addr</i>	
vlan <i>vlan-id</i>	VLAN

```
show mac-address-table filtering
```

```
00d0.f800.0c0c
```

```
Ruijie# clear mac-address-table filtering address 00d0.f800.0c0c
```

mac-address-table filtering	
show mac-address-table filtering	

--	--	--

no mac-address-table aging-time



show mac-address-table filtering

Ruijie(config)# **mac-address-table filtering 00d0f8000000 vlan 1**

clear mac-address-table filtering	
show mac-address-table filtering	

-	-

11.1.11 mac-address-table notification

MAC **no**

mac-address-table notification [interval *value* | history-size *value*]

no mac-address-table notification [interval | history-size]

interval <i>value</i>	MAC	Trap	1
history-size <i>value</i>	MAC		50

1 50

MAC Trap
snmp-server enable traps mac-notification
 MAC Trap

Ruijie(config)# **mac-address-table notification**
 Ruijie(config)# **mac-address-table notification interval 40**
 Ruijie(config)# **mac-address-table notification history-size 100**



show mac-address-table static	
clear mac-address-table static	

S2900

MAC	16K
MAC	1K

-	-

11.1.13 snmp trap mac-notification

MAC **no**

snmp trap mac-notification {added | removed}

no snmp trap mac-notification {added | removed}

added	
removed	

show mac-address-table notification *interface*

```
Ruijie(config)# interface gigabitethernet 1/1
Ruijie(config-if)# snmp trap mac-notification added
```

mac-address-table notification	MAC
show mac-address-table notification	MAC



|

|

|

```
Ruijie# show address-bind
IP Address      Binding MAC Addr
-----
3.3.3.3        00d0.f811.1112
3.3.3.4        00d0.f811.1117
```

|

address-bind	

|

MAC

show mac-address-table dynamic	
show mac-address-table interface	
show mac-address-table vlan	VLAN
show mac-address-table count	
show mac-address-table static	
show mac-address-table filtering	

-	-

11.2.4 show mac-address-table aging-time

show mac-address-table aging-time

-	-

└───

└───

└───

```
Ruijie# show mac-address-table aging-time
Aging time   : 300
```

mac-address-table aging-time	

└───

MAC

	-	-

11.2.5 show mac-address-table count

show mac-address-table count

	-	-

|

|

|

Ruijie#

-	-
---	---

11.2.6 show mac-address-table dynamic

show mac-address-table dynamic [**address** *mac-addr*] [**interface** *interface-id*] [**vlan** *vlan-id*]

<i>mac-addr</i>	MAC
<i>vlan-id</i>	VLAN
<i>interface-id</i>	(AggregatePort)

┌
└
┌
└
┌
└

Ruijie# **show mac-address-table dynamic**

Vlan	MAC Address	Type	Interface
----	-----	-----	-----
1	0000.0000.0001	DYNAMIC	gigabitethernet 1/1
1	0001.960c.a740	DYNAMIC	gigabitethernet 1/1
1	0007.95c7.dff9	DYNAMIC	gigabitethernet 1/1
1	0007.95cf.eee0	DYNAMIC	gigabitethernet 1/1
1	0007.95cf.f41f	DYNAMIC	gigabitethernet 1/1
1	0009.b715.d400	DYNAMIC	gigabitethernet 1/1
1	0050.bade.63c4	DYNAMIC	gigabitethernet 1/1

clear mac-address-table dynamic	
--	--

┌
└
┌
└

--	--

MAC

	-	-
--	---	---

11.2.7 show mac-address-table filtering

show mac-address-table static [**addr** *mac-addr*] [**vlan** *vlan-id*]

<i>mac-addr</i>	MAC
<i>vlan-id</i>	VLAN

MAC

<i>interface-id</i>	(AggregatePort)
<i>vlan-id</i>	VLAN

┌
└

┌
└

┌
└

Ruijie#

interface <i>interface-id</i>	MAC
<i>history</i>	MAC

MAC

```
Ruijie# show mac-address-table notification interface
```

```
Interface          MAC Added Trap  MAC Removed Trap
```

```
-----
GigabitEthernet1/14  Disabled          Disabled
```

```
Ruijie# show mac-address-table notification
```

```
MAC Notification Feature : Disabled
```

```
Interval between Notification Traps : 1 secs
```

```
Maximum Number of entries configured in History Table :1
```

```
Current History Table Length : 0
```

```
Ruijie# show mac-address-table notification history
```

```
History Index : 0
```

```
MAC Changed Message :
```

```
Operation:ADD Vlan : 1 MAC Addr: 00f8.d012.3456 GigabitEthernet 3/1
```

mac-address-table notification	MAC
snmp trap mac-notification	MAC

show mac-address-table static [**addr** *mac-addr*] [**interface** *interface-id*] [**vlan** *vlan-id*]

<i>vlan-id</i>	VLAN ID
----------------	---------

┌

┌

┌

```
Ruijie# show mac-address-table vlan 1
Vlan    MAC Address      Type      Interface
-----  -
1       00d0.f800.1001  STATIC   gigabitethernet 1/1
1       00d0.f800.1002  STATIC   gigabitethernet 1/1
1       00d0.f800.1003  STATIC   gigabitethernet 1/1
```

show mac-address-table static	
show mac-address-table filtering	
show mac-address-table dynamic	
show mac-address-table address	
show mac-address-table interface	
show mac-address-table count	

┌

-	-
---	---

11.2.12 show mac-address-learning

--	--

┌

1

Ruijie# show mac-address-learning

--

--

12 DHCP Snooping

12.1 DHCP snooping

12.1.1 ip dhcp snooping

```
DHCP Snooping                                no
      DHCP Snooping
```

[no] ip dhcp snooping

-	-

└───

└───

DHCP Snooping	show ip dhcp snooping	DHCP			
<table style="width: 100%; border-collapse: collapse;"> <tr> <td style="text-align: center; width: 33%;">DHCP Snooping</td> <td style="text-align: center; width: 33%;">Private VLAN</td> <td style="width: 34%;"></td> </tr> </table>			DHCP Snooping	Private VLAN	
DHCP Snooping	Private VLAN				

└───

```

DHCP snooping
Ruijie# configure terminal
Ruijie(config)# ip dhcp snooping
Ruijie(config)# end
Ruijie# show ip dhcp snooping

Switch DHCP snooping status    ENABLE
Verification of hwaddr field status  DISABLE
DHCP snooping database write-delay time: 0 seconds
DHCP snooping option 82 status: ENABLE
DHCP snooping Support Bootp bind status: ENABLE
Interface                Trusted    Rate limit (pps)
-----                -

```

--	--

show ip dhcp snooping		DHCP snooping
	-	-

12.1.2 ip dhcp snooping bootp-bind

```
DHCP Snooping      Bootp
no                  DHCP snooping      Bootp
```

[no] ip dhcp snooping bootp-bind

	-	-

```
┌
```

```
┌
```

```

                DHCP Snooping      Bootp
DHCP Snooping   Bootp              Bootp      DHCP
DHCP Snooping   Bootp              DHCP

```

```

                DHCP Snooping      Bootp
Ruijie# configure terminal
Ruijie(config)# ip dhcp snooping bootp-bind
Ruijie(config)# end
Ruijie# show ip dhcp snooping
Switch DHCP snooping status      ENABLE
Verification of hwaddr field status  DISABLE
DHCP snooping database write-delay time: 0 seconds
DHCP snooping option 82 status: ENABLE
DHCP snooping Support Bootp bind status: ENABLE
Interface           Trusted           Rate limit (pps)
-----

```

	show ip dhcp snooping	DHCP snooping

	-	-

12.1.4 ip dhcp snooping database write-to-flash

DHCP Snooping

FLASH

ip dhcp snooping database write-to-flash

	-	-

└───

└───

-	-
---	---

12.1.5 ip dhcp snooping information option

DHCP option82
no

[no] ip dhcp snooping information option

-	-

┌

┌

┌

DHCP option82 DHCP option82

```

DHCP                      option82
Ruijie# configure terminal
Ruijie(config)# ip dhcp snooping information option
Ruijie(config)# end
Ruijie# show ip dhcp snooping
Switch DHCP snooping status    ENABLE
Verification of hwaddr field status    DISABLE
DHCP snooping database write-delay time: 0 seconds
DHCP snooping option 82 status: ENABLE
DHCP snooping Support Bootp bind status: ENABLE
Interface                      Trusted      Rate limit (pps)
-----

```

show ip dhcp snooping	DHCP snooping

┌

--	--

DHCP

no

[no] ip dhcp snooping limit rate *rate-value*

<i>rate-value</i>	PPS[Packet Per Second]

```

DHCP Snooping      VLAN
                    CPP[CPU Protect Protocol]      CPP      DHCP
                    CPP                            DHCP Snooping
CPP
show ip dhcp snooping
    
```

```

1          100pps
Ruijie# configure terminal
Ruijie(config)# interface fastEthernet 0/1
Ruijie(config-if)# ip dhcp snooping limit rate 100
Ruijie(config-if)# end
Ruijie# show ip dhcp snooping
Switch DHCP snooping status  ENABLE
Verification of hwaddr field status  DISABLE
DHCP snooping database write-delay time: 0 seconds
DHCP snooping option 82 status: ENABLE
DHCP snooping Support Bootp bind status: ENABLE
Interface          Trusted      Rate limit (pps)
-----
FastEthernet0/1    NO          100
    
```

show ip dhcp snooping	DHCP snooping

DHCP snooping TRUST
 no UNTRUST

[no] ip dhcp snooping trust

-	-

UNTRUST

	DHCP	TRUST
DHCP	UNTRUST	DHCP

```

fastEthernet 0/1 TRUST
Ruijie# configure terminal
Ruijie(config)# interface fastEthernet 0/1
Ruijie(config-if)# ip dhcp snooping trust
Ruijie(config-if)# end
Ruijie# show ip dhcp snooping
Switch DHCP snooping status    ENABLE
Verification of hwaddr field status    DISABLE
DHCP snooping database write-delay time: 0 seconds
DHCP snooping option 82 status: ENABLE
DHCP snooping Support Bootp bind status: ENABLE
Interface                            Trusted            Rate limit (pps)
-----
FastEthernet0/1                      YES                unlimited
    
```



12.3 DHCP snooping

12.3.1 show ip dhcp snooping

┌

┌

-	-

12.3.2 show ip dhcp snooping binding

DHCP Snooping

show ip dhcp snooping binding

┌

-	-

┌

┌

┌

DHCP Snooping

```
Ruijie# show ip dhcp snooping binding
Total number of bindings: 1

MacAddress      IPAddress      Lease(sec)  Type         VLAN  Interface
-----
0000.0000.0001  1.1.1.1       78128      dhcp-snooping  1    FastEthernet 0/1
```

┌

ip dhcp snooping binding	DHCP snooping
clear ip dhcp snooping binding	DHCP snooping

┌

┌

--	--

DHCP Snooping

debug ip dhcp snooping {

13 IGMP Snooping

13.1

13.1.1 deny

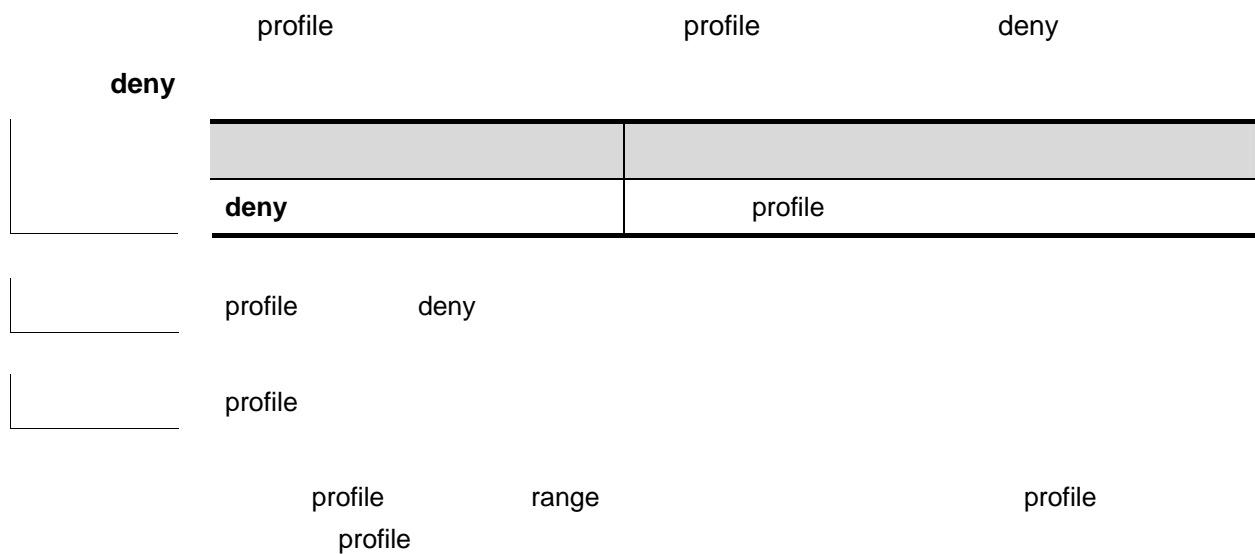

profile profile permit profile

permit

permit	profile

profile deny

profile

profile range profile
profile

224.2.2.2 profile
Ruijie(config)# **ip igmp profile 1**
Ruijie(config-profile)# **range 224.2.2.2**
Ruijie(config-profile)# **permit**

ip igmp profile	profile
range	

-	-

13.1.3 range

profile profile range
no

range *low-ip-address* [*high-ip-address*]

no range *low-ip-address* [*high-ip-address*]

<i>low-ip-address</i>	

<i>high-ip-address</i>	
------------------------	--

--	--

profile	
---------	--

	profile	deny
profile	profile	

```

                224.2.2.2~224.2.2.244    profile
Ruijie(config)# ip igmp profile 1
Ruijie(config-profile)# range 224.2.2.2 224.2.2.244
    
```

ip igmp profile	profile
deny	profile deny
permit	profile permit

--	--

-	-

13.1.4 ip igmp profile

IGMP profile profile profile
 profile profile-number igmp profile

ip igmp profile *profile-number*

no ip igmp profile *profile-number*

<i>profile-number</i>	profile 1-65535

```

IGMP Profiles                               " SVGL                               " "
                                           " " IGMP Filtering "           profile
                                           profile
    
```

```

                                           1 profile profile
Ruijie(config)# ip igmp profile 1
Ruijie(config-profile)#
    
```

range	profile	
permit	profile	permit
deny	profile	deny

```

    
```

-	-

13.1.5 ip igmp snooping ivgl

```

igmp snooping ivgl ip igmp snooping ivgl
no igmp snooping
    
```

ip igmp snooping ivgl

no ip igmp snooping

-	-

```

disable
    
```

```

    
```

```

VLAN VLAN VLAN VLAN
VLAN
    
```

```

pim snooping          igmp snooping  IVGL  IVGL-SVGL
no ip igmp snooping  igmp snooping
pim snooping          pim snooping
    
```

```

Ruijie(config)# ip igmp snooping ivgl
    
```

ip igmp snooping svgl	igmp snooping svgl
ip igmp snooping ivgl-svgl	igmp snooping

```

    
```

-	-

13.1.6 ip igmp snooping vlan

```

vlan          igmp snooping          ivgl          ip igmp
snooping vlan          no          igmp snooping
ip igmp snooping vlan vid
no ip igmp snooping vlan vid
    
```

vid	vlan id

```

disable
    
```

```

    
```

```

vlan          IGMP Snooping
-----
vlan          pim snooping          igmp snooping
no ip igmp snooping vlan          igmp snooping
pim snooping          VLAN          pim snooping
    
```

```

                vlan 2      igmp snooping
Ruijie(config)# ip igmp snooping vlan 2
    
```

ip igmp snooping ivgl	igmp snooping ivgl
ip igmp snooping ivgl-svgl	igmp snooping

-	-

13.1.7 ip igmp snooping svgl profile

```

                profile      SVGL      ip igmp snooping svgl
profile          no
ip igmp snooping svgl profile profile-number
no ip igmp snooping svgl profile
    
```

<i>profile-number</i>	profile <1-65536>

```

                svgl      profile
    
```

```

                SVGL      IVGL-SVGL
    
```

```

                igmp snooping svgl      profile 2
Ruijie(config)# ip igmp snooping svgl profile 2
    
```

ip igmp snooping svgl	igmp snooping svgl
ip igmp snooping ivgl-svgl	igmp snooping

ip igmp snooping fast-leave enable

no ip igmp snooping fast-leave enable

-	-

disable

IP IGMP

IP IGMP

igmp snooping fast-leave

Ruijie(config)# **ip igmp snooping fast-leave enable**

-	-

-	-

13.1.10 ip igmp snooping query-max-response-time

query

ip igmp snooping query-max-response-time *time*

no ip igmp snooping query-max-response-time

<i>time</i>	

10s

┌

┌

```

IGMP
                                0
                                IGMP Snooping

IGMP
                                0
                                IGMP Snooping

IGMPv3
    
```

┌

```

                                100s
Ruijie(config)# ip igmp snooping query-max-response-time 100
    
```

┌

┌

┌

-	-

13.1.11 ip igmp snooping limit-ipmc

```

no IP IP ip igmp snooping limit-ipmc vlan
    
```

ip igmp snooping limit-ipmc vlan *vid address gaddress server saddress*

no ip igmp snooping limit-ipmc vlan *vid address gaddress server saddress*

┌

<i>vid</i>	ip vlan id
<i>gaddress</i>	
<i>saddress</i>	()

┌

┌

IP

ip

Ruijie(config)# **ip igmp snooping limit-ipmc vlan 1 address 224.0.0.1 server 192.168.4.243**

ip igmp snooping source-check default-server	IP IP

-	-

13.1.12 ip igmp snooping suppression enable

igmp snooping Report
suppression enable no **ip igmp snooping**
 igmp snooping suppression
ip igmp snooping suppression enable
no ip igmp snooping suppression enable

-	-

disable

IGMP
 vlan IGMP Report
 IGMP Report IGMPv1/v2 report
 suppression
 IGMPv3 report

igmp snooping suppression

Ruijie(config)# **ip igmp snooping suppression**



	ip igmp snooping vlan mrouter learn pim-dvmrp	vlan
	-	-

13.1.14 ip igmp snooping vlan mrouter interface

ip igmp snooping vlan mrouter interface *interface-id* , **no**

ip igmp snooping vlan *vid* **mrouter interface** *interface-id*

no ip igmp snooping vlan *vid* **mrouter interface** *interface-id*

	<i>vid</i>	vlan id
	<i>interface-id</i>	id

IP

```
Ruijie(config)# ip igmp snooping vlan 1 mrouter interface
fastEthernet 0/1
```

	ip igmp snooping source-check port	
--	---	--

	-	-

13.1.15 ip igmp snooping vlan mrouter learn pim-dvmrp

IGMP Query/Dvmrp/PIM Hello
ip igmp snooping vlan mrouter learn no

ip igmp snooping vlan *vid* mrouter learn pim-dvmrp

no ip igmp snooping vlan *vid* mrouter learn pim-dvmrp

	<i>vid</i>	vlan id

┌

┌

VLAN

no ip igmp snooping filter *profile-number*

<i>profile-number</i>	profile <1-65536>

┌

┌

IGMP Profile	IGMP Report
	IGMP Profile
	profile filter

```

                                0/1    profile 1
Ruijie(config)# interface fastEthernet 0/1
Ruijie(config-if)# ip igmp snooping filter 1
    
```

ip igmp profile	profile

┌

-	-

13.1.18 ip igmp snooping max-groups

max-groups no , **ip igmp snooping**

ip igmp snooping max-groups *number*

no ip igmp snooping max-groups

<i>number</i>	<0 – 1024>

┌

IGMP Report

```

0/1      100
Ruijie(config)# interface fastEthernet 0/1
Ruijie(config-if)# ip igmp snooping max-group 100
    
```

ip igmp snooping filter	
-	-

13.2

13.2.1 show ip igmp snooping

igmp snooping

Show ip igmp snooping [gda-table | interfaces | mrouter/ statistics [vlan *vlan-id*]

	igmp snooping
gda-table	
interfaces	igmp snooping filtering
mrouter	
statistics [vlan <i>vlan-id</i>]	snooping
vlan	vlan snooping

EXEC

┌

┌

┌

-	-

┌

┌

-	-

13.2.2 show ip igmp profile [profile-number]

┌

	profile
<i>profile-number</i>	profile

┌

┌

EXEC

┌

profile

┌



IGMP Snooping Debug

no

debug igmp-snp
debug igmp-snp event
debug igmp-snp packet
debug igmp-snp msf
debug igmp-snp warning
undebug igmp-snp
undebug igmp-snp event
undebug igmp-snp packet
undebug igmp-snp msf
undebug igmp-snp warning

	IGMP Snooping
event	IGMP Snooping
packet	IGMP Snooping
msf	IGMP Snooping
warning	IGMP Snooping

EXEC

-	-

-	-

14 DHCPV6 Snooping

14.1

14.1.1 ipv6 dhcp snooping

```
dhcpv6 snooping no dhcpv6  
snooping
```

```
ipv6 dhcp snooping
```

```
no ipv6 dhcp snooping
```

	-	-

```
|
```

```
|
```

```
|
```

```
dhcpv6 snooping show ipv6 dhcp  
snooping dhcpv6 snooping
```

```
|
```

```
1 dhcpv6 snooping  
Ruijie(config)# ipv6 dhcp snooping
```

```
|
```

show ipv6 dhcp snooping	dhcpv6 snooping

```
|
```

no

ipv6 dhcp snooping binding-delay *seconds*

no ipv6 dhcp snooping binding-delay

<i>time</i>	

|

|

|

IPv6

1 10

Ruijie(config)# **ipv6 dhcp snooping binding-delay 10**

|

10.4	

14.1.3 ipv6 dhcp snooping database write-delay

dhcpv6 snooping

flash

no

ipv6 dhcp snooping database write-delay *time*

no ipv6 dhcp snooping database write-delay

--	--

|

|

dhcpv6 snooping flash
IP

|

1 flash 100
Ruijie(config)# ipv6 dhcp snooping database write-delay 100

|

show ipv6 dhcp snooping	dhcpv6 snooping

|

|

10.4	

14.1.4 ipv6 dhcp snooping database write-to-flash

|

dhcpv6 snooping flash
ipv6 dhcp snooping database write-to-flash

-	

|

|

dhcpv6 snooping flash
flash

	10.4	

14.1.5 ipv6 dhcp snooping filter-dhcp-pkt

```

                                dhcpv6                                no
ipv6 dhcp snooping filter-dhcp-pkt
no ipv6 dhcp snooping filter-dhcp-pkt

```

--	--	--

└───┘

└───┘

└───┘

```

1      fastethernet 0/1      dhcpv6
Ruijie(config)# interface fastethernet 0/1
Ruijie(config-if)# ipv6 dhcp snooping filter-dhcp-pkt

```

	-	-

└───┘

	10.4	

14.1.6 ipv6 dhcp snooping ignore dest-not-found

" " no DHCPv6

ipv6 dhcp snooping ignore dest-not-found

no ipv6 dhcp snooping ignore dest-not-found

--	--

└──

└──

DHCPv6	MAC	MAC	DHCPv6	MAC
" DHCPV6_SNOOPING-5-DEST_NOT_FOUND: Could not find destination port. Destination MAC [mac-address]"				
	MAC		DHCPv6	VLAN

1
Ruijie(config)# **ipv6 dhcp snooping ignore dest-not-found**

show ipv6 dhcp snooping	dhcpv6 snooping

└──

10.4	

14.1.7 ipv6 dhcp snooping link-detection

LINK DOWN no

ipv6 dhcp snooping link-detection

no ipv6 dhcp snooping link-detection

┌

┌

┌

LINK DOWN
LINK DOWN

┌

1 LINK DOWN
Ruijie(config)# **ipv6 dhcp snooping link-detection**

┌

show ipv6 dhcp snooping	dhcpv6 snooping

┌

10.4	

14.1.8 ipv6 dhcp snooping trust

dhcpv6 snooping trust no
untrust

ipv6 dhcp snooping trust

no ipv6 dhcp snooping trust

┌

┌

untrust

┌

┌

dhcpv6 trust trust dhcpv6 Server
untrust dhcpv6 Server

```

1          fastethernet 0/1  trust
Ruijie(config)# interface fastethernet 0/1
Ruijie(config-if)# ipv6 dhcp snooping trust
    
```

show ipv6 dhcp snooping	dhcpv6 snooping

10.4	

14.1.9 Ipv6 dhcp snooping vlan

```

vlan          dhcpv6 snooping          no
vlan          dhcpv6 snooping
    
```

ipv6 dhcp snooping {*vlan-list* | {*vlan-min* [*vlan-max*]}}

no ipv6 dhcp snooping {*vlan-list* | {*vlan-min* [*vlan-max*]}}

<i>vlan-list</i>	vlan 1,3-5,7,9-11
<i>vlan-min</i>	vlan id
<i>vlan-max</i>	vlan id

```

dhcpv6 snooping          vlan
    
```

```

dhcpv6 snooping          vlan  dhcpv6 snooping
vlan          dhcpv6 snooping          vlan          dhcpv6 snooping
    
```

```

1  vlan 1          dhcpv6 snooping
Ruijie(config)# no ipv6 dhcp snooping vlan 1
    
```

--	--

	-	-
	10.4	

14.1.10 ipv6 source binding

no

ipv6 source binding *mac-address* **vlan** *vlan-id* *ipv6-address* **interface** *interface-name*

no ipv6 source binding *mac-address* **vlan** *vlan-id* *ipv6-address* **interface** *interface-name*

<i>mac-address</i>	MAC
<i>vlan-id</i>	VLAN
<i>ipv6-address</i>	IPV6
<i>interface-name</i>	

```

IPV6          DHCPV6          IPV6

1
Ruijie(config)# ipv6 source binding 00d0.f866.4777 vlan 10
                2001:2002::2003 interface fastethernet 0/10
    
```

--	--

	10.4	
--	-------------	--

14.1.11 ipv6 verify source

no

ipv6 verify source [port-security]

no ipv6 verify source

	port-security	MAC + IPV6 IPV6 IPV6
		MAC IPV6

┌

┌

┌

IPV6 DHCPV6 IPV6

┌

```

1            fastethernet 0/1    MAC+IPV6
Ruijie(config)# interface fastethernet 0/1
Ruijie(config-if)# ipv6 verify source port-security
    
```

┌

┌

┌

	10.4	

14.2

14.2.1 show ipv6 dhcp snooping

dhcpv6 snooping

show ipv6 dhcp snooping

-	-

└───

└───

└───

dhcpv6 snooping

1 dhcpv6 snooping

Ruijie# show ipv6 dhcp snooping

```
Switch DHCPv6 snooping status  ENABLE
DHCPv6 snooping vlan: 1-4094
DHCPv6 snooping database write-delay time: 0 seconds
DHCPv6 ignore dest-not-found :DISABLE
DHCPv6 snooping link detection :DISABLE
```

Interface	Trusted	Filter DHCP
-----	-----	-----
FastEthernet0/10	yes	DISABLE

└───

└───

└───

10.4	

14.2.2 show ipv6 dhcp snooping binding

dhcpv6 snooping

show ipv6 dhcp snooping binding [ipv6-address] [mac-address] [vlan vlan_id]
 [interface interface_name]

	vlan <i>vlan_id</i>	VLAN
	interface <i>interface_name</i>	

|

|

dhcpv6 snooping

dhcpv6 snooping

show ipv6 source binding [*ipv6-address*] [*mac-address*] [**vlan** *vlan_id*]
[**interface** *interface_name*] [**dhcp-snooping** | **static**]

BDC1627F(2)T10051138706E74T005113685452129607685.52f1296.7756711291.6706211291.6139

14.3.1 clear ipv6 dhcp snooping binding

dhcpv6 snooping

clear ipv6 dhcp snooping binding [*ipv6-address*] [*mac-address*] [**vlan** *vlan_id*]
[**interface** *interface_name*]

<i>ipv6-address</i>	ipv6
<i>mac-address</i>	mac
vlan <i>vlan_id</i>	VLAN
interface <i>interface_name</i>	

dhcpv6 snooping

1 dhcpv6 snooping

Ruijie# **clear ipv6 dhcp snooping binding**

10.4	

14.3.2 clear ipv6 dhcp snooping prefix

dhcpv6 snooping

clear ipv6 dhcp snooping prefix [*ipv6-prefix*] [*mac-address*] [**vlan** *vlan_id*]
[**interface** *interface_name*]

--	--

<i>ipv6-prefix</i>	ipv6
<i>mac-address</i>	mac
vlan <i>vlan_id</i>	VLAN
interface <i>interface_name</i>	

└───┘

└───┘

└───┘

dhcpv6 snooping

└───┘

1 dhcpv6 snooping
Ruijie# **clear ipv6 dhcp snooping prefix**

└───┘

└───┘

└───┘

10.4	

14.3.3 clear ipv6 dhcp snooping statistics

dhcpv6 snooping dhcpv6

clear ipv6 dhcp snooping statistics

└───┘

-	-

└───┘

└───┘

└───┘

dhcpv6 snooping dhcpv6

	10.4	

15 ND Snooping

15.1

15.1.1 ipv6 nd snooping

```

IPv6 ND snooping                               no          IPv6 ND
Snooping
ipv6 nd snooping
no ipv6 nd snooping

```

--	--

--	--

```

          ipv6 nd snooping

```

```

          IPv6 ND snooping
Ruijie# configure terminal
Enter configuration commands, one per line.  End with CNTL/Z.
Ruijie(config)# ipv6 nd snooping

```

show ipv6 nd snooping	ipv6 nd snooping

--	--

--	--

10.4(2)	

15.1.2 ipv6 nd snooping vlan

VLAN IPv6 ND snooping no VLAN
 IPv6 ND Snooping
ipv6 nd snooping vlan {vlan-rng | {vlan-min [vlan-max]}}
no ipv6 nd snooping vlan {vlan-rng | {vlan-min [vlan-max]}}

<i>vlan-rng</i>	vlan
<i>vlan-min</i>	vlan
<i>vlan-max</i>	vlan

vlan ipv6 nd snooping

1 VLAN 100 IPv6 ND Snooping
 Ruijie# **configure terminal**
 Enter configuration commands, one per line. End with CNTL/Z.
 Ruijie(config)# **no ipv6 nd snooping vlan 100**

2 VLAN 4 5-7 15 IPv6 ND Snooping
 Ruijie# **configure terminal**
 Enter configuration commands, one per line. End with CNTL/Z.
 Ruijie(config)# **no ipv6 nd snooping vlan 4,5-7,15**

show ipv6 nd snooping	ipv6 nd snooping

15.1.5 ipv6 nd snooping detect gateway

no

ipv6 nd snooping detect gateway ra
no ipv6 nd snooping detect gateway ra

VLAN

Ruijie#

<i>vlan-rng</i>	vlan
<i>vlan-min</i>	vlan
<i>vlan-max</i>	vlan

VALN

```
Ruijie# configure terminal
Enter configuration commands, one per line. End with CNTL/Z.
Ruijie(config)# ipv6 nd snooping detect gateway vlan 8
```

show ipv6 nd snooping	nd snooping

10.4(2)	

15.1.7 ipv6 nd snooping key-node

ND

no

```
ipv6 nd snooping key-node [link-local vid]ipv6_address/prefix_len
no ipv6 nd snooping key-node [link-local vid] ipv6_address/prefix_len
```

<i>vid</i>	link-local VID

<i>ipv6_address/prefix_len</i>	IPv6

```
Ruijie# configure terminal
Enter configuration commands, one per line. End with CNTL/Z.
Ruijie(config)#ipv6 nd snooping key-node 2003::1/128
```

show ipv6 nd snooping key-node	nd snooping

10.4(2)	

15.1.8 ipv6 nd snooping monitor stateless-user

no

```
ipv6 nd snooping monitor stateless-user
no ipv6 nd snooping monitor stateless-user
```

ND

Ruijie# **configure terminal**

Enter configuration commands, one per line. End with CNTL/Z.

Ruijie(config)#**no ipv6 nd snooping monitor stateless-user**

show ipv6 nd snooping stateless-user	

10.4(2)	

15.1.9 ipv6 nd snooping stateless-user combine-security

no

ipv6 nd snooping stateless-user combine-security

no ipv6 nd snooping stateless-user combine-security

```
Ruijie# configure terminal
Enter configuration commands, one per line. End with CNTL/Z.
Ruijie(config)# ipv6 nd snooping stateless-user combine-security
```

show ipv6 nd snooping	ipv6 nd snooping

10.4(2)	

15.1.10 ipv6 nd snooping stateless-user address-bind

IPv6

no

```
ipv6 nd snooping stateless-user address-bind [strict] [ip-mac]
no ipv6 nd snooping stateless-user address-bind
```

strict	link-local link-local link-local
ip-mac	IP+MAC IP

```

Ruijie# configure terminal
Enter configuration commands, one per line. End with CNTL/Z.
Ruijie(config)# ipv6 nd snooping stateless-user address-bind
                2                               IP+MAC
Ruijie# configure terminal
Enter configuration commands, one per line. End with CNTL/Z.
Ruijie(config)#ipv6 nd snooping stateless-user address-bind strict
ip-mac
    
```

show ipv6 nd snooping		ipv6 nd snooping

Enter configuration commands, one per line. End with CNTL/Z.
Ruijie(config)# **ipv6 nd snooping stateless-user station-move**



show ipv6 nd snooping	ipv6 nd snooping
10.4(2)	

15.1.13 ipv6 nd snooping stateless-user per-vlan prefix-limit

```

                VLAN      IPv6
ipv6 nd snooping stateless-user per-vlan prefix-limit num
no ipv6 nd snooping stateless-user per-vlan prefix-limit

```

<i>num</i>	VLAN IPv6

2

```

                VLAN      4      IPv6
Ruijie# configure terminal
Enter configuration commands, one per line. End with CNTL/Z.
Ruijie(config)#ipv6 nd snooping stateless-user per-vlan
prefix-limit 4

```

show ipv6 nd snooping	ipv6 nd snooping
------------------------------	------------------

10.4(2)	
---------	--

15.1.14 clear ipv6 nd snooping key-node

clear ipv6 nd snooping key-node [vlan *vid*]

<i>vid</i>	VLAN

Ruijie# **clear ipv6 nd snooping key-node**

10.4(2)	

15.1.15 clear ipv6 nd snooping stateless-user

clear ipv6 nd snooping stateless-user [vlan *vid*]

<i>vid</i>	VLAN

```
Ruijie# clear ipv6 nd snooping stateless-user
```

10.4(2)	

15.1.16 clear ipv6 nd snooping prefix

VLAN

```
clear ipv6 nd snooping prefix [vid vlan]
```

<i>vlan</i>	VLAN

IPv6

```
Ruijie# clear ipv6 nd snooping prefix
```

--	--

15.2.2 show ipv6 nd snooping key-node

show ipv6 nd snooping key-node

|

|

|

|

Ruijie# **show ipv6 nd snooping key-node**

|

10.4(2)	

15.2.3 show ipv6 nd snooping stateless-user

```
ipv6
show ipv6 nd snooping stateless-user
```

```
|
```

```
|
```

```
|
```

```
Ruijie# show ipv6 nd snooping stateless-user
```

```
|
```

10.4(2)	

```
$1-CtNQ-rQ,
```

ND Snooping

16 MSTP

16.1

16.1.1 bpdu src-mac-check

bpdu mac no bpdu mac

bpdu src-mac-check *H.H.H*

no bpdu src-mac-check

<i>H.H.H</i>	mac	bpdu
no	bpdu	

|

|

|

```
Ruijie(config)# interface gigabitethernet 1/1
Ruijie(config-if)# bpdu src-mac-check 00d0.f800.1e2f
```

-	-

|



RSTP BPDU BPDU

clear spanning-tree detected-protocols [interface *interface-id*]

	<i>interface-id</i>	

|

|

|

|

Ruijie# **clear spanning-tree detected-protocols**

	show spanning-tree interface	STP

|

	-	-

16.1.3 spanning-tree

MSTP MSTP MSTP
no spanning-tree no spanning tree

spanning-tree [forward-time *seconds* | hello-time *seconds* | max-age *seconds*]

no spanning-tree [forwa Td[(no spannin)5(g)-10.001 Tc 0.0032 Tw 5.251 0 Td<01C4>Tj/TT1 1 Tf-0.000

forward-time hello-time max-age

$2 * (\text{Hello Time} + 1.0\text{snd}) \leq \text{Max-Age Time} \leq 2 * (\text{Forward-Delay} - 1.0\text{snd})$

```

1 spanning-tree
Ruijie(config)# spanning-tree

2 BridgeForwardDelay
Ruijie(config)# spanning-tree forward-time 10
  
```

show spanning-tree	STP
spanning-tree mst cost	STP PathCost
spanning-tree tx-hold-count STP	TxHoldCount

-	-

16.1.4 spanning-tree autoedge

Autoedge disabled Autoedge

spanning-tree autoedge [disabled]

disabled	Autoedge

	-	-
--	---	---

16.1.6 spanning-tree bpduguard

	BPDU Guard	enabled	disabled
spanning-tree bpduguard			
	enabled		EA /
	disabled		BPDU Guard

Bä]xa ìÿ= Ã ðÀ % 3• Ð• HNBf9€ f"7Nf9€ v B NöhD†vc Nû4B ñ e%" 0CE I3L> xâ4Ãb3\ LN b2f"R C,

	-	-



root guard



16.1.14 spanning-tree mode

STP no

spanning-tree mode [stp | rstp | mstp]

no spanning-tree mode

stp	Spanning tree protocol(IEEE 802.1d)
rstp	Rapid spanning tree protocol(IEEE 802.1w)
mstp	Multiple spanning tree protocol(IEEE 802.1s)

MSTP

.

Ruijie(config)# **spanning-tree mode stp**

show spanning-tree	

-	-

```
VLAN 3 Instance 1 MST
Ruijie(config-mst)# no instance 1 vlan 3
Instance 1
Ruijie(config-mst)# no instance 1
MST show
```



MSTP

MSTP

Region

```

mst 20 GigabitEthernet 1/1 10
Ruijie(config)# interface gigabitEthernet 1/1
Ruijie(config-if)# spanning-tree mst 20 port-priority 0
show spanning-tree mst instance interface interface-id
```

Instance 20

8192

Ruijie(config-if)# **spanning-tree mst 20 priority 8192**

show spanning-tree mst instance interface interface-id

20

	show spanning-tree interface	STP
	-	-

16.1.20 spanning-tree portfast

	Portfast	disabled
	Portfast	Portfast
	spanning-tree portfast [disabled]	
	disabled	Portfast
	-	
	<pre>Ruijie(config)# interface gigabitethernet 1/1 Ruijie(config-if)# spanning-tree portfast</pre>	
	show spanning-tree interface	STP
	-	-

16.1.21 spanning-tree portfast bpdudfilter default

	BPDU filter	no
	BPDU filter	BPDU filter
	spanning-tree portfast bpdudfilter default	

```
Ruijie(config)# spanning-tree portfast bpduguard default
```

show spanning-tree interface	STP

-	-

16.1.23 spanning-tree portfast default

Portfast no Portfast

spanning-tree portfast default

no spanning-tree portfast default

-	-

Portfast

16.1.24 spanning-tree reset

	spanning-tree	no
	spanning-tree reset	
	-	-
	Ruijie(config)# spanning-tree reset	
	show spanning-tree	STP
	show spanning-tree interface	STP
	-	-

16.1.25 spanning-tree tc-guard

	tc-guard	no	tc-guard	tc-guard
	tc			
	spanning-tree tc-guard			
	no spanning-tree tc-guard			
	-		-	
	tc-guard			

|

|

|

Ruijie(config-if)# **spanning-tree tc-guard**

|

-	-

|

|

-	-

16.1.26 spanning-tree tc-protection

tc- protection

no

tc- protection

spanning-tree tc- protection

no spanning-tree tc- protection

|

-	-

|

tc- protection

<i>tx-hold-count</i>	TxHoldCount	1	10

3

Ruijie(config)# **spanning-tree tx-hold-count 5**

--	--

show spanning-tree

tx-hold-count	TxHoldCount
pathcost method	

|

|

|

|

Ruijie# **show spanning-tree hello-time**



link-type	linktype
------------------	----------

┌

┌

┌

Ruijie# **show spanning-tree interface gigabitethernet 1/5**

spanning-tree bpdupfilter	BPDU filter
spanning-tree portfast	portfast
spanning-tree bpduguard	BPDU guard
spanning-tree link-type	“ ”

┌

-	-

16.2.3 show spanning-tree mst

MST Instance

show spanning-tree mst { **configuration** | *instance-id* [**interface** *interface-id*] }

configuration	mst
<i>instance-id</i>	<i>Instance</i>
<i>interface-id</i>	

Instance

.

Ruijie# **show spanning-tree mst configuration**



17 SPAN

17.1

17.1.1 monitor session

SPAN . no

monitor session *session_number* {**source interface** *interface-id* [**both** | **rx** | **tx**] | **destination interface** *interface-id* { **encapsulation** | **switch** } | **mac** {**source** *mac-addr* | **destination** *mac-addr* } [**both** | **rx** | **tx**] [**acl** *name*]

no monitor session *session_number* [**source interface** *interface-id* [**both** | **rx** | **tx**] | **destination interface** *interface-id* { **encapsulation** | **switch** }] | **mac** {**source** *mac-addr* | **destination** *mac-addr* } [**both** | **rx** | **tx**] [**acl** *name*]

no monitor session all

<i>session_number</i>	SPAN
source interface <i>interface-id</i>	<i>interface-id</i> SVI
destination interface <i>interface-id</i>	<i>interface-id</i> SVI
mac source <i>mac-addr</i>	

18 IP

18.1

18.1.1 ip address

IP

no

IP

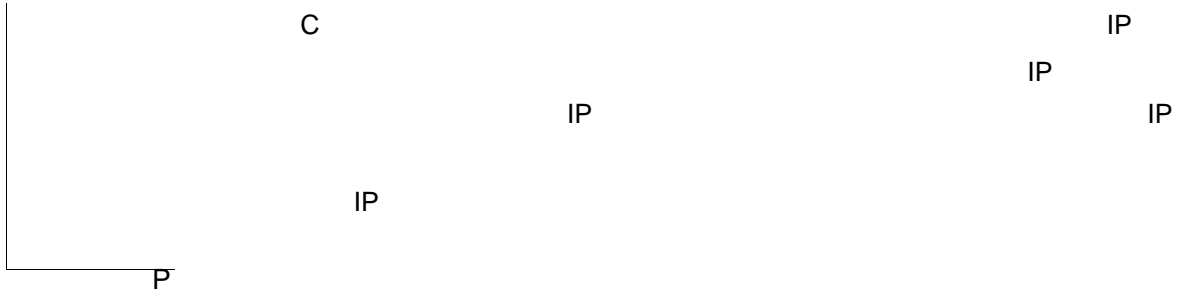

```
IP      10.10.10.1      255.255.255.0
ip address 10.10.10.1 255.255.255.0
```

show interface	

SLIP HDLC PPP LAPB Frame-relay

X.25

ping
SNMP

IP

FastEthernet 0/1

IP
ip unnumbered fastEthernet 0/1

show interface	

-	-

18.2

18.2.1 arp

ARP IP MAC no
MAC

arp [vrf name] ip-address MAC-address type

no arp [vrf name] ip-address

vrf name	VRF name VRF
ip-address	MAC IP
MAC-address	48
type	ARP arpa



ARP



&b-Á±

RGOS

ARP

32

IP

48

MAC

ARP

ARP

clear

```
1          SVI 1          ARP
Ruijie(config)# interface vlan 1
Ruijie(config-if)# arp gratuitous-send interval 1

2          SVI 1          ARP
Ruijie(config)# interface vlan 1
Ruijie(config-if)# no arp gratuitous-send
```



IP

	Arp retry times <i>number</i>	ARP
--	--------------------------------------	-----

--

ARP no

8192

arp unresolve number

no arp unresolve

<i>number</i>	ARP < 1-8192
	> 8192

ARP 8192

┌

ARP

500

arp unresolved 500

-	-

┌

-	-

18.2.7 ip proxy-arp

ARP ip proxy-arp no

ARP

ip proxy-arp

no ip proxy-arp

-	-

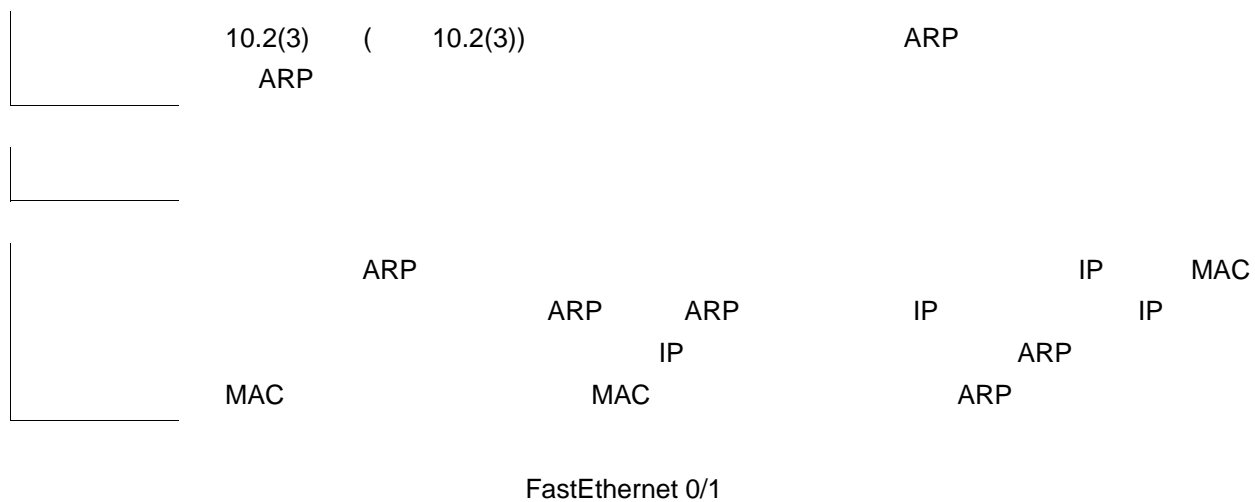

IP

mask

ARP

mask

vrf <i>vrf_name</i>	VRF	VRF	ARP
trusted		ARP	VRF

Age (min)	
Hardware	
Type	
Interface	

“_”

show arp 192.168.195.68

show arp Protocol Address Age(min) P

-	-

-	-

18.3.3

show arp counter

--	--

-	-
---	---

--

--

--

```

show arp counter
Ruijie# show arp counter
The Arp Entry counter:0
The Unresolve Arp Entry:0
    
```

-	-
---	---

--

-	-
---	---

18.3.4 show arp detail

ARP

show arp detail [*interface-type interface-number*] *ip* [*mask*] | *mac-address* | **static** | **complete** | **incomplete**]

<i>interface-type interface-number</i>	ARP
<i>ip</i>	ip ip ARP
<i>ip mask</i>	ip mask ARP
<i>mac-address</i>	mac ARP
static	arp
complete	arp
incomplete	arp

ARP

ARP

show arp detail

Ruijie# **show arp detail**

IP Address	MAC Address	Type	Age(min)	Interface	Port
20.1.1.1	000f.e200.0001	Static	-- --	--	
20.1.1.1	000f.e200.0001	Static	-- VI3	--	
20.1.1.1	000f.e200.0001	Static	-- VI3	Gi2/0/1	
193.1.1.70	00e0.fe50.6503	Dynamic	1 VI3	Gi2/0/1	
192.168.0.1	0012.a990.2241	Dynamic	10 Gi2/0/3	Gi2/0/3	
192.168.0.1	0012.a990.2241	Dynamic	20 Ag1	Ag1	
192.168.0.1	0012.a990.2241	Dynamic	30 VI2	Ag2	
192.168.0.39	0012.a990.2241	Local	-- VI3	--	
192.168.0.39	0012.a990.2241	Local	-- Gi2/0/3	--	
192.168.0.1	0012.a990.2241	Local	-- VI3	--	
192.168.0.1	0012.a990.2241	Local	-- Gi2/3/2	--	

ARP

IP Address	IP
MAC Address	IP
Type	ARP
Age	ARP
Interface	IP
Port	ARP

18.3.6 show ip arp

ARP

show ip arp

-	-

┌

┌

┌

show ip arp

Ruijie# **show ip arp**

```

Protocol Address      Age(min)Hardware      Type
Interface
Internet 192.168.7.233  23  0007.e9d9.0488  ARPA FastEthernet 0/0
Internet 192.168.7.112  10  0050.eb08.6617  ARPA FastEthernet 0/0
Internet 192.168.7.79   12  00d0.f808.3d5c  ARPA FastEthernet 0/0
Internet 192.168.7.1    50  00d0.f84e.1c7f  ARPA FastEthernet 0/0
Internet 192.168.7.215  36  00d0.f80d.1090  ARPA FastEthernet 0/0
Internet 192.168.7.127  0   0060.97bd.ebee  ARPA FastEthernet 0/0
Internet 192.168.7.195  57  0060.97bd.ef2d  ARPA FastEthernet 0/0
Internet 192.168.7.183  --  00d0.f8fb.108b  ARPA FastEthernet 0/0

```

ARP

Protocol	Internet
Address	IP
Age (min)	ARP “_”
Hardware	IP
Type	ARPA
Interface	IP

-	-

┌

-	-

18.3.7 show ip interface

IP

show ip interface [*interface-type interface-number*]

<i>Interface-type</i>	
<i>Interface-number</i>	

┌

┌

```

RGOS                RGOS                RGOS
                    " UP"
                    " UP"
                    " UP"
    
```

┌

```

show ip interface
Ruijie# show ip interface FastEthernet 0/1
IP interface state is: UP
IP interface type is: BROADCAST
IP interface metric is: 0
IP interface MTU is: 1500
IP address is:
192.168.5.133/24 (primary)
IP address negotiate is: OFF
    
```

Forward direct-boardcast is: ON
ICMP mask reply is: ON
Send ICMP redirect is: ON
Send ICMP unreachableled is: ON
DHCP relay is: OFF
Fast switch is: ON

┌

┌

-	-

18.3.8 show ip redirects

show ip redirects

┌

-	-

┌

┌

┌

┌

show ip redirects

Ruijie# **show ip redirects**

Default Gateway: 192.168.195.1

┌

ip default-gateway	

┌

┌

-	-

18.4

18.4.1 ip default-gateway

ip default-gateway no

ip default-gateway

no ip default-gateway

	-	-

|

|

|

show ip redirects

|

192.168.1.1

ip default-gateway 192.168.1.1

|

	show ip redirects	

|

|

	-	-

19 DHCP Relay

19.1

19.1.1 ip dhcp relay check server-id

```
DHCP Relay    check server-id          no
DHCP Relay    check server-id
```

[no] ip dhcp relay check server-id

-	-

└───

└───

```

DHCP Relay    DHCP    option server-id
DHCP          DHCP    DHCP

```

```

DHCP relay    check server-id

```

```
Ruijie# configure terminal
```

```
Ruijie(config)# ip dhcp relay check server-id
```

Service dhcp	DHCP

└───

-	-

19.1.2 ip dhcp relay information option dot1x

DHCP Relay option dot1x

no

[no] ip dhcp relay information option dot1x



|

|

option dot1x

|

DHCP

option82

Ruijie# **configure terminal**

Ruijie(config)# **ip dhcp relay information option82**

|

Service dhcp	DHCP
ip dhcp relay information option dot1x	DHCP option dot1x

	ip dhcp relay information option dot1x	DHCP option dot1x
	-	-

19.1.5 ip dhcp relay suppression

DHCP Relay no
DHCP relay

[no] ip dhcp relay suppression

	-	-

┌

└

┌

└

DHCP

1 DHCP relay

```
Ruijie# configure terminal
Ruijie(config)# interface fastEthernet 0/1
Ruijie(config-if)# ip dhcp relay suppression
Ruijie(config-if)# exit
Ruijie(config)#
```

	service dhcp	DHCP

┌

└

	-	-

19.1.6 ip helper-address

DHCP no
DHCP

`[no] ip helper-address [vrf vrf-name]A.B.C.D`

-	-



/

20 DHCP

DHCP

DHCP Relay

DHCP

~~#IP-ADRESSE: 192.168.1.1 DHCP-Relay~~
~~#IP-ADRESSE: 192.168.1.1 DHCP-Relay~~
~~#IP-ADRESSE: 192.168.1.1 DHCP-Relay~~
~~#IP-ADRESSE: 192.168.1.1 DHCP-Relay~~

DHCP

no

[no] service dhcp



20 DNS

20.1

20.1.1 ip domain-lookup

	DNS	no	DNS
	ip domain-lookup		
	no ip domain-lookup		
	-		-
	DNS		
	DNS		DNS
	DNS		
	Ruijie(config)# ip domain-lookup		
	show hosts		DNS
	-		-

20.1.2 ip name-server

✘ IP/IPv6

ip name-server {*ip-address* | *ipv6-address*}

no ip name-server [*ip-address* | *ipv6-address*]

<i>ip-address</i>	IP
<i>ipv6-address</i>	IPV6

┌

┌

DNS Server	IP/IPv6	DNS Server	DNS Server
Server		Server	DNS
6	DNS Server	ip-address	ipv6-address
	DNS		

Ruijie(config)# **ip name-server** 192.168.5.134
 Ruijie(config)# **ip name-server**
 2001:0DB8::250:8bff:fee8:f800 2001:0DB8:0:f004::1

show hosts	DNS

┌

-	-

	<i>ip-address</i>	IP
		no ip host host-name ip-address
		Ruijie(config)# ip host switch 192.168.5.243
	show hosts	DNS
	-	-

20.1.4 ipv6 host

	IPV6	no
	ipv6 host host-name ipv6-address	
	no ipv6 host host-name ipv6-address	
	<i>host-name</i>	
	<i>ipv6-address</i>	IPV6
		no ipv6 host host-name ipv6-address
		Ruijie(config)# ipv6 host ruijie 2001:0DB8:700:20:1::12

show hosts	DNS

┌

-	-

20.2

20.2.1 clear host

clear host [*host-name*]

<i>host-name</i>	(((**)))

┌

┌

2 DNS	1 ip host ipv6 host DNS

┌

clear host * -IP

show hosts	

┌

-	-

20.2.2 show hosts

DNS

show hosts [*hostname*]

-	-

└───┘

└───┘

└───┘

DNS

```
Ruijie# show hosts
Name servers are:
static
host          type          address
switch        static        192.168.5.243
www.ruijie.com dynamic       192.168.5.123
```

ip host	IP
ipv6 host	IPV6
ip name-server	DNS

└───┘

-	-

21 SNTP

21.1

21.1.1 sntp enable

	SNTP	no	—Disable
[no] sntp enable			
	-	-	
	SNTP	Disable	
	show sntp	SNTP	
	Ruijie(config)# sntp enable		
	show sntp	SNTP	
	clock update-calendar		
	clock set		
	RGOS10.0		
	-	-	

21.1.2 sntp interval

SNTP Client NTP/SNTP Server

sntp interval *seconds*

SNTP

|

|

show sntp SNTP

|

Ruijie(config)# **sntp server** 192.168.4.12

|

	,D%6% 1"5MSF,PI,ITFE'@eāX
show sntp	SNTP

|

SNTP

SNTP sync interval : 60
Time zone : +8

sntp enable	SNTP
show sntp	SNTP

RGOS10.0

-	-

22 NTP

22.1 NTP

22.1.1 no ntp

	ntp	ntp
no ntp		
┌		
└	-	-
┌	NTP	
└		
┌	NTP	NTP
└	NTP	NTP
┌	no ntp	NTP
└		
┌		
└	ntp server	NTP
┌		
└	-	-

22.1.2 ntp access-group

NTP
no

ntp access-group { **peer** | **serve** | **serve-only** | **query-only** } *access-list-number* | *access-list-name*

no ntp access-group{**peer** | **serve** | **serve-only** | **query-only**}*access-list-number* | *access-list-name*

peer	NTP
serve	NTP
serve-only	NTP
query-only	NTP
<i>access-list-number</i>	IP 1 99 1300 1999
<i>access-list-name</i>	IP

NTP

NTP
NTP
NTP

peer serve serve-only query-only

1
2

Ruijie(config)# **ntp access-group peer 1**

Ruijie(config)# **ntp access-group serve-only 2**

ip access-list	IP

	-	-

22.1.3 ntp authenticate

NTP NTP

ntp authenticate

no ntp authenticate

	-	-

NTP

ntp authentication-key ntp trusted-key

NTP

NTP

ntp authentication-key *key-id* **md5** *key-string* [*enc-type*]

no ntp authentication-key *key-id* **md5** *key-string* [*enc-type*]

<i>key-id</i>	ID
<i>key-string</i>	
<i>enc-type</i>	0

NTP

	-	-
--	---	---

.



┌

┌

NTP

Ntp synchronize

┌

ntp server	NTP

┌

┌

-	-

22.1.9 ntp trusted-key

ID

ntp trusted-key *key-id*

no ntp trusted-key *key-id*

┌

<i>key-id</i>	ID

┌

┌

┌

NTP

ID

┌

```
ntp authentication-key 6 md5 woooooop
ntp trusted-key 6
ntp server 192.168.210.222 key 6
```

┌

--	--

NTP

	-	-

22.2

22.2.1 debug ntp

NTP

debug ntp

no debug ntp

	-	-

--

--

--

NTP

--

NTP

debug ntp

	-	-

--

	-	-

22.2.2 show ntp status

NTP

show ntp status



23 FTP Server

23.1

23.1.1 debug ftpserver

FTP no

debug ftpserver

no debug ftpserver

	-	-

|

|

|

debug ftpserver FTP

1

Ruijie# **debug ftpserver**

FTPSRV_DEBUG:(RECV) SYST

FTPSRV_DEBUG:(REPLY) 215 RGOS Type: L8

FTPSRV_DEBUG:(RECV) PORT 192,167,201,82,7,120

FTPSRV_DEBUG:(REPLY) 200 PORT Command okay.

2

Ruijie# **no debug ftpserver**

|

	-	-

|

|

--	--	--

	-	-
--	---	---

23.1.2 ftp-server enable

FTP no FTP

ftp-server enable

no ftp-server enable

	-	-



FTP

FTP

ftp-server topdir

FTP

!60B

FTP

ftp-server password [*type*] *password*

no ftp-server password

<i>type</i>	0 7 0
<i>password</i>	7

┌

┌

FTP

	1	25	4
52			
FTP			

```

1          pass
Ruijie(config)# ftp-server password pass

Ruijie(config)# ftp-server password 0 pass
2          8001
Ruijie(config)# ftp-server password 7 8001
3
Ruijie(config)# no ftp-server password
    
```

-	-

┌

-	-

23.1.4 ftp-server topdir

FTP

no

FTP

ftp-server topdir *directory*

no ftp-server topdir

<i>directory</i>	FTP



FTP

¥ K€

SNMP

no snmp-server chassis-id

<i>text</i>	

```

60FF60

```

```

```

```

SNMP
show snmp

```

```

SNMP 123456:
Ruijie(config)# snmp-server chassis-id 123456

```

show snmp	SNMP

```

```

-	-

24.1.3 snmp-server community

```

SNMP
no SNMP
snmp-server community string [view view-name] [[ro | rw] [host ipaddr] ] [ number ipv6
ipv6-aclname][aclnum | aclname]

```

```

no snmp-server community string

```

<i>string</i>	NMS SNMP
<i>view-name</i>	
ro	NMS MIB
rw	NMS MIB

<i>aclnumber</i>	1-99 MIB ipv4 NMS
<i>aclname</i>	MIB ipv4 NMS
<i>ipv6_aclname</i>	ipv6 MIB ipv6 NMI>Tj.(v6)-5(N)-7(M)2Nv6@f,d@f-rdC"U5F"CU

<i>text</i>	

┌

┌

┌

SNMP i-net800@i-net.com.cn
 Ruijie(config)# **snmp-server contact** *i-net800@i-net.com.cn*

show snmp-server	SNMP
no snmp-server	SNMP

┌

-	-

24.1.5 snmp-server enable traps

SNMP NMS Trap
snmp-server enable traps no SNMP NMS
 Trap

snmp-server enable traps [snmp]

no snmp-server enable traps

snmp	SNMP

┌

┌

	<i>ipv6_aclname</i>	ipv6 MIB ipv6 NMS
--	---------------------	-------------------------

<i>port-num</i>	snmp
<i>notification-type</i>	snmp

SNMP

snmp-server enable traps NMS
SNMP
vrf [vrf]

SNMP SNMP
Ruijie(config)# snmp-server host 192.168.12.219 public snmp

snmp-server enable traps	

-	-

24.1.8 snmp-server location

SNMP snmp-server location no
SNMP

<i>text</i>	

|

|

|

Ruijie(config)# **snmp-server location** start-technology-city 4F of A Buliding

|

snmp-sever contact	SNMP

|

|

-	-

24.1.9 snmp-server packetsiz

SNMP

snmp-sever packetsize

no

snmp-server packetsize *byte-count*

no snmp-server packetsize

|

<i>byte-count</i>	484 17876

|

1500

|

|

|

SNMP

1492

Ruijie(config)# **snmp-server packetsize** 1492

|

--	--

	snmp-server queue-length	SNMP
--	---------------------------------	------

--

--	--	--

SNMP

no

SNMP

snmp-server system-shutdown

snmp-server system-shutdown

no snmp-server system-shutdown

-	-

SNMP

SNMP

RGOS

reload/reboot

NMS

SNMP

Ruijie(config)# **snmp-server system-shutdown**

-	-

-	-

24.1.12 snmp-server trap-source

SNMP

snmp-server trap-source

no

snmp-server trap-source *interface*

no snmp-server trap-source

<i>interface</i>	SNMP

SNMP

IP

|

|

SNMP

IP
IP SNMP

|

0 IP SNMP

Ruijie(config)# **snmp-server trap-source fastethernet 0**

|

snmp-server enable traps	
snmp-server enable host	NMS

|

|

-	-

24.1.13 snmp-server trap-timeout

snmp-server trap-timeout

no

snmp-server trap-timeout *seconds*

no snmp-server trap-timeout

|

seconds	1 – 1000

|

30

|

|

|

60

Ruijie(config)# **snmp-server trap-timeout 60**

	snmp-server queue-length	
	snmp-server enable host	NMS

	(E	A
	-	-

24.1.14 snmp-server user

SNMP

snmp-servesnmp-servme grou 06(pna)-6(me).84 719.36 0.24



|

default

MIB

|

|

|

MIB-2 oid 1.3.6.1

Ruijie(config)# **snmp-server view mib2 1.3.6.1 include**

|

show snmp view	SNMP

|

|

-	-

24.1.16 snmp trap link-status

24.2

24.2.1 show snmp

SNMP

show snmp

show snmp [mib | user | view | group| host]

|

-	-

|

|

|

show snmp

SNMP

```

show snmp mib                snmp mib
show snmp user             snmp
show snmp view            snmp
show snmp group          snmp
show snmp host

```

SNMP

```

Ruijie# show snmp
Chassis: 60FF60
0 SNMP packets input
0 Bad SNMP version errors
0 Unknown community name
0 Illegal operation for community name supplied
0 Encoding errors
0 Number of requested variables
0 Number of altered variables
0 Get-request PDUs
0 Get-next PDUs
0 Set-request PDUs
0 SNMP packets output
0 Too big errors (Maximum packet size 1500)
0 No such name errors
0 Bad values errors
0 General errors
0 Response PDUs
0 Trap PDUs
SNMP global trap: disabled
SNMP logging: disabled
SNMP agent: enabled

```

snmp-server chassis-id	SNMP

-	-

25 RMON

25.1

25.1.1 rmon alarm

MIB no

rmon alarm *number variable interval {absolute | delta } rising-threshold value [event-number] falling-threshold value [event-number] [owner ownname]*

no rmon alarm *number*

-	-

┌

┌

RGOS variable
 absolute/delta owner interval rising-threshold/falling-threshold event

MIB ifInNUcastPkts.6
 Ruijie(config)# **rmon alarm** 10 1.3.6.1.2.1.2.2.1.12.6 30 **delta**
rising-threshold 20 1 **falling-threshold** 10 1 **owner** zhangsan

rmon event <i>number [log] [trap community] [description-string]</i>	

┌

-	-

25.1.2 rmon collection history

no

rmon collection history *index* [**owner** *ownername*] [**buckets** *bucket-number*] [**interval** *seconds*]

no rmon collection history *index*

-	-

└──

└──

RGOS	owner buckets
interval	

└──

1

Ruijie(config)# **interface fast-Ethernet 0/1**

Ruijie(config-if)# **rmon collection history 1 zhansan buckets 10 interval 10**

rmon collection stats <i>index</i> [owner <i>owner-name</i>]	

└──

-	-

25.1.3 rmon collection stats

no

rmon collection stats *index* [**owner** *owner-string*]

no rmon collection stats *index*

	-	-

|

|

|



trap

Ruijie(config)# **rmon event**

Event type : log-and-trap
Community : public
Last time sent : 0d:0h:0m:0s
Owner : zhangsan
Log : 1
Log time : 0d:0h:37m:47s

```
Ruijie# show rmon event
Alarm : 1
Interval : 1
Variable : 1.3.6.1.2.1.4.2.0
Sample type : absolute
Last value : 64
Startup alarm : 3
Rising threshold : 10
Falling threshold : 22
Rising event : 0
Falling event : 0
Owner : zhangsan
```

--	--

rmon event *number* [**log**] [

```

Ruijie# show rmon history
Entry : 1
Data source : Gil/1
Buckets requested : 65535
Buckets granted : 10
Interval : 1
Owner : zhangsan
Sample : 198
Interval start : 0d:0h:15m:0s
DropEvents : 0
Octets : 67988
Pkts : 726
BroadcastPkts : 502
MulticastPkts : 189
CRCAlignErrors : 0
UndersizePkts : 0
OversizePkts : 0
Fragments : 0
Jabbers : 0
Collisions : 0
Utilization : 0
    
```

rmon collection history <i>index</i> [owner ownername] [buckets bucket-number] [interval seconds]	

-	-

|
 |
 |
 |

```

Ruijie# show rmon statistics
Statistics : 1
Data source : Gil/1
DropEvents : 0
Octets : 1884085
Pkts : 3096
BroadcastPkts : 161
MulticastPkts : 97
CRCAlignErrors : 0
UndersizePkts : 0
OversizePkts : 1200
Fragments : 0
Jabbers : 0
Collisions : 0
Pkts64Octets : 128
Pkts65to127Octets : 336
Pkts128to255Octets : 229
Pkts256to511Octets : 3
Pkts512to1023Octets : 0
Pkts1024to1518Octets : 1200
Owner : zhangsan
  
```

|
 |
 |

rmon collection stats <i>index</i> [owner <i>owner-string</i>]	

	-	-

26 IPv6

26.1

26.1.1 ping ipv6

IPV6

ping ipv6 [ipv6-address]

ipv6-addres	s

└───┘

└───┘

└───┘

└───┘

Ruijie# ping ipv6 fec0::1

ping

!	
.	
U	
R	
F	
A	
D	Down IPV6 ()
?	

└───┘

-	-



-	-

26.1.2 ipv6 address

IPV6 ,

IPV6

UP IPV6 4

|



default

2	IPv6	ipv6 enable
	IPv6	
	no ipv6 enable	IPv6

Ruijie(config-if)# **ipv6 enable**

show ipv6 interface	
----------------------------	--

-	-
---	---

26.1.5 ipv6 general-prefix

IPv6

ipv6 general-prefix

ipv6 general-prefix *prefix-name ipv6-prefix/prefix-length*

no ipv6 general-prefix *prefix-name ipv6-prefix/prefix-length*

<i>prefix-name</i>	
<i>ipv6-prefix</i>	RFC4291
<i>prefix-length</i>	

IPv6

my-prefix

Ruijie(config)# **ipv6 general-prefix** my-prefix 2001:1111:2222::/48

ipv6 address prefix-name

sub-bits/prefix-length

	-	-
	-	-

26.1.7 ipv6 nd dad attempts

```

                IPV6                                (NS)
                no
    ipv6 nd dad attempts value
    no ipv6 nd dad attempts
    
```

value	(NS)	0
	0-600	ipv6 :

```

1

```

```

                IPV6
                "tentative"( )
                EUI-64
                (                IPV6                )
                down/up
                down                up
    
```

```

Ruijie(config)# interface vlan 1
Ruijie(config-if)# ipv6 nd dad attempts 3
    
```

show ipv6 interface	

IPv6

no

ipv6 neighbor *ipv6-address interface-id hardware-address*

no ipv6 neighbor *ipv6-address interface-id*

<i>ipv6-address</i>	IPV6	RFC4291	
<i>interface-id</i>	SVI	Routed Port,L3 AP	
<i>hardware-address</i>	MAC	XXXX.XXXX.XXXX	48
	'X'		

ARP

IPV6

NDP

Reachble

IPV6

IPV6

mac

inactive

show ipv6 neighbor static

clear ipv6 neighbors

(NDP)

show ipv6 neighbors

Ruijie(conifg)# **ipv6 neighbor 2001::1 vlan 1 00d0.f811.1111**

show ipv6 neighbors	
clear ipv6 neighbors	



" no ipv6
IPv6

ns-linklocal-src
RFC3484

ipv6 ns-linklocal-src

no ipv6 ns-linklocal-src

-	-

|

|

|

|

Ruijie(config)# no ipv6 ns-linklocal-src

-	-

|

-	-

26.1.11 ipv6 route

IPV6

no

ipv6 route *ipv6-prefix/prefix-length* {*ipv6-address* | *interface-id* [*ipv6-address*]}

no ipv6 route *ipv6-prefix/prefix-length* {*ipv6-address* | *interface-id* [*ipv6-address*]}

IPv6	
<i>ipv6-prefix</i>	IPV6 RFC4291

<i>ipv6-address</i>	RFC4291
<i>interface-id</i>	

┌

┌

Ruijie(config)# **ipv6 route 2001::/64 vlan 1 2005::1**

show ipv6 route	IPv6

┌

-	-

26.1.12 ipv6 source-route

	IPv6	no
IPv6		
ipv6 source-route		
no ipv6 source-route		

	-	-

|

IPv6

|

|

0

IPv6

0

IPv6

|

Ruijie(config)# **no ipv6 source-route**

|

	-	-

26.2

26.2.1 clear ipv6 neighbors

clear ipv6 neighbors

	-	-

└───

└───

└───

└───

Ruijie# **clear ipv6 neighbors**

	ipv6 neighbor	
	show ipv6 neighbors	

└───

	-	-

26.2.2 show ipv6 general-prefix

show ipv6 general-prefix

show ipv6 general-prefix

	-	-



```

Ruijie# show ipv6 interface vlan 1
Interface vlan 1 is Up, ifindex: 2001
address(es):
Mac Address: 00:00:00:00:00:01
INET6: fe80::200:ff:fe00:1 , subnet is fe80::/64
INET6: 2001::1 , subnet is 2001::/64 [TENTATIVE]
Joined group address(es):
ff01:1::1
ff02:1::1
ff02:1::2
ff02:1::1:ff00:1
MTU is 1500 bytes
ICMP error messages limited to one every 10 milliseconds
ICMP redirects are enabled
ND DAD is enabled, number of DAD attempts: 1
ND reachable time is 30000 milliseconds
ND advertised reachable time is 0 milliseconds
ND retransmit interval is 1000 milliseconds
ND advertised retransmit interval is 0 milliseconds
ND router advertisements are sent every 200 seconds<240--160>
ND router advertisements live for 1800 seconds

```

INET6: 2001::1 , subnet is 2001::/64

[TENTATIVE]	INET6	[]
ANYCAST		
TENTATIVE		(DAD)
DUPLICATED		
DEPRECATED		
NODAD		
AUTOIFID		EUI-64
PRE		
GEN		

```
Ruijie# show ipv6 interface vlan 1 ra-info
```

total	
fec0:1:1:1::/64	
Def	
Auto CFG	Auto IPV6 , CFG
!Adv	
vtime	()
ptime	()
L !L	L !L on-link
A !A	A

1 SVI 1

Ruijie# **show ipv6 neighbors vlan 1**

```
IPv6 Address Linklayer Addr Interface
fa::1          00d0.0000.0002 vlan 1
fe80::200:ff:fe00:2 00d0.0000.0002 vlan 1
```

2

Ruijie# **show ipv6 neighbors verbose**

```
IPv6 Address Linklayer Addr Interface
2001::1       00d0.f800.0001 vlan 1
                State: Reach/H Age: - asked: 0
fe80::200:ff:fe00:1 00d0.f800.0001 vlan 1
                State: Reach/H Age: - asked: 0
```

IPv6 Address	IPV6
Linklayer Addr	Mac incomplete
Interface	

```

                                state/H(R)
STATE
INCMP( Incomplete)—
                                (NS)
                                (NA)
REACH(Reachable) —

                                STALE —

                                NUD
( Neighbor Unreachability Detection )
DELAY—                                STALE
                                STALE    DELAY
State                                DELAY_FIRST_PROBE_TIME seconds(5 )

                                DELAY    PROBE
                                (NS)    NUD
PROBE—    NUD
                                RetransTimer milliseconds
                                (NS)

MAX_UNICAST_SOLICIT(3 )
?—
/R—

```

Interface	
State	STATE ACTIVE— INACTIVE— IPV6 mac

ipv6 neighbor	
---------------	--

-	-
---	---

26.2.5 show ipv6 route

IPV6

show ipv6 route [static] [local] [connected]

static	
local	
connected	

Ruijie# **show ipv6 route**

Codes: C - Connected, L - Local, S - Static, R - RIP, B - BGP

I1 - ISIS L1, I2 - ISIS L2, IA - IIS interarea

```
L   ::1/128
    via ::1, loopback 0
C   fa::/64
    via ::, vlan 1
L   fa::1/128
    via ::, loopback 0
C   2001::/64
    via ::, vlan 2
L   2001::1/128
    via ::, loopback 0
L   fe80::/10
    via ::1, Null0
C   fe80::/64
    via ::, vlan 1
L   fe80::200:ff:fe00:1/128
    via ::, loopback 0
C   fe80::/64
    via ::, vlan 2
```



ipv6 route

show ipv6 router

IPv6

Ruijie# **show ipv6 router**

Router FE80::2D0:F8FF:FEC1:C6E1 on VLAN 2, last update 62 sec
Hops 64, Lifetime 1800 sec, ManagedFlag=0, OtherFlag=0, MTU=1500
Preference=MEDIUM
Reachable time 0 msec, Retransmit time 0 msec
Prefix 6001:3::/64 onlink autoconfig
Valid lifetime 2592000 sec, preferred lifetime 604800 sec
Prefix 6001:2::/64 onlink autoconfig
Valid lifetime 2592000 sec, preferred lifetime 604800 sec

-	-



27 MLD Snooping

27.1

27.1.1 ipv6 mld profile

MLD profile profile profile-number mld
profile

	10.4	

27.1.3 deny

	profile	profile	deny
	deny		
	profile	deny	
	profile		
	profile	range	
		FF77::100	profile :
	Ruijie(config)# ipv6 mld profile 1		
	Ruijie(config-profile)# range FF77::100		
	Ruijie(config-profile)# deny		
	ipv6 mld profile	profile	
	range		
	permit	profile	permit
	10.4		

27.1.4 permit

	profile	profile	permit
	permit		

┌

┌

┌

┌

┌

	VLAN		VLAN	VLAN
	VLAN		VLAN	
		mld snooping	ivgl	
	Ruijie(config)# ipv6 mld snooping ivgl			
	ipv6 mld snooping svgl	mld snooping	svgl	
	ipv6 mld snooping ivgl-svgl	mld snooping		
	10.4			

27.1.6 ipv6 mld snooping dyn-mr-aging-time

ipv6 mld snooping dyn-mr-aging-time *time*
no ipv6 mld snooping dyn-mr-aging-time

ipv6 mld snooping dyn-mr-aging-time *time*
no ipv6 mld snooping dyn-mr-aging-time

┌

┌

┌

┌

┌

<i>time</i>			1-3600
300s			
Hello		MLD	IPv6 PIM
		500s	

Ruijie(config)# **ipv6 mld snooping dyn-mr-aging-time 500**

--	--

MLD query PIM
ipv6 mld snooping vlan mrouter learn no

ipv6 mld snooping vlan *vid* mrouter learn
no ipv6 mld snooping vlan *vid* mrouter learn

<i>vid</i>	vlan	id	1-4094

VLAN

ipv6 mld snooping vlan *vid* mrouter interface *interface-id*

<i>vid</i>	vlan id	1-4094
<i>ipv6-multiaddr</i>		
<i>interface-id</i>		

└───┘

└───┘

└───┘

```

                                FF88::1
Ruijie(config)# ipv6 mld snooping vlan 1 static FF88::1 interface
fastEthernet 0/1
    
```

ipv6 mld snooping vlan mrouter interface	

└───┘

10.4	

27.1.12 ipv6 mld snooping fast-leave enable

```

                                mld snooping fast-leave          ipv6 mld snooping
fast-leave enable                no                mld snooping fast-leave
ipv6 mld snooping fast-leave enable
no ipv6 mld snooping fast-leave enable
    
```

└───┘

└───┘

```
Ruijie(config)# ipv6 mld snooping suppression
```

10.4	

27.1.14 ipv6 mld snooping filter

```
profile          no          profile
```

```
ipv6 mld snooping filter profile-number
```

```
no ipv6 mld snooping filter profile-number
```

<i>profile-num</i>	profile

MLD Profile

MLD Report
MLD Profile
profile

filter

0/1 profile 1

```
Ruijie(config)# interface fastEthernet 0/1
```

```
Ruijie(config-if)# ipv6 mld snooping filter 1
```

ipv6 mld profile	profile

	10.4	

clear ipv6 mld snooping gda-table

|

|

|

|

Ruijie# **clear ipv6 mld snooping gda-table**

|

10.4	

27.1.17 debug mld-snp

mld , debug mld-snp

debug mld-snp
undebug mld-snp

|

|

|

mld

|

mld

```
Ruijie# debug mld-snp
```

10.4	

27.2

27.2.1 show ipv6 mld snooping

```
mld snooping
```

```
Show ipv6 mld snooping [gda-table | interfaces | mrouter/ statistics [vlan vlan-id ]
```

	mld snooping
gda-table	
interfaces	mld snooping Filtering
mrouter	
statistics [vlan <i>vlan-id</i>]	snooping

```
mld snooping
```

```
1 show ipv6 mld snooping mld snooping
```

```
Ruijie# show ipv6 mld snooping
```

```
MLD-snooping mode      : IVGL
SVGL vlan-id           : 1
SVGL profile number    : 0
Source check port      : Disabled
```

```
Query max response time : 10(Seconds)
2 show ipv6 mld snooping statistics mld snooping
```

```
Ruijie# show ipv6 mld snooping statistics
```

```
GROUP      Interface      Last report      Last leave      Last
           time         time            reporter
-----
FF88::1 VL1:Gi4/2  0d:0h:0m:7s    ----          2003::1111
           Report pkts: 1          Leave pkts: 0
```

```
3 show ipv6 mld snooping mrouter mld snooping
```

```
Ruijie# show ipv6 mld snooping mrouter
```

```
Vlan      Interface      State      MLD profile number
-----
1 GigabitEthernet 0/7  static      1
1 GigabitEthernet 0/12 dynamic     0
```

```
4 show ipv6 mld snooping gda-table GDA
```

```
Ruijie# show ipv6 mld snooping gda-table
```

```
Abbr: M - mrouter
      D - dynamic
      S - static
```

```
VLAN Address      Member ports
-----
1 FF88::1      GigabitEthernet 0/7(S)
```

```
5 show ipv6 mld snooping interface mld snooping Filtering
```

```
Ruijie# show ipv6 mld snooping interface GigabitEthernet 0/7
```

```
Interface      Filter Profile number      max-groups
-----
GigabitEthernet 0/7          1          4294967294
```

--	--

10.4

27.2.2 show ipv6 mld profile

MLD profile

show ipv6 mld profile [*profile-number*]

	profile
<i>profile-number</i>	profile

mld profile

```

1      show ipv6 mld profile      MLD profile
Ruijie# show ipv6 mld profile 1
MLD Profile 1
permit
range FF77::1 FF77::100
range FF88::123
    
```

10.4

28

28.1

28.1.1 storm-control

no

storm-control {**broadcast** | **multicast** | **unicast**} [{**level percent** | **pps packets** | **rate-bps**}]

no storm-control {**broadcast** | **multicast** | **unicast**} [{**level percent** | **pps packets** | **rate-bps**}]

broadcast	
multicast	
unicast	
<i>percent</i>	20 20%
<i>packets</i>	pps packets per second
<i>Rate-bps</i>	
<i>64k-2M</i>	64k

2-100M

1M

187.1 0. 20.1 ref296.7 92 Tw 11MBT 602.0 100.0

GigabitEthernet 1/1

4M

Ruijie# **configure terminal**

Ruijie(config)# **interface GigabitEthernet 1/1**

Ruijie(config-if)# **storm-control multicast 4096**

Ruijie(config-if)# **end**

show storm-control	

86 **pps**

-	-

28.1.2 switchport protected

no

switchport protected

no switchport protected

-	-

3

show interfaces

Ruijie(config)# **interface gigabitethernet 1/1**

Ruijie(config-if)# **switchport protected**

show interfaces	

┌

-

┌

-	-

28.1.3 switchport port-security

no

switchport port-security [violation {protect | restrict | shutdown}]

no switchport port-security [violation]

┌

port-security	
violation protect	
violation restrict	trap
violation shutdown	Trap

┌

┌

┌

) (MAC IP()
 1
 M

Gigabitethernet 1/1

shutdown

	show port-security	
--	---------------------------	--

--

switchport port-security	
switchport port-security binding interface	
Switchport port-security mac-address	
switchport port-security aging	
show port-security	

└───

└───

-	-

28.1.6 switchport port-security binding interface

IP+ MAC IP

no

[no] switchport port-security binding interface *interface-id* *mac-address* **vlan** *vlan_id* *ipv4-address* | *ipv6-address*

[no] switchport port-security binding interface *interface-id* *ipv4-address* | *ipv6-address*

<i>interface-id</i>	ID
<i>mac-address</i>	MAC
<i>Vlan_id</i>	MAC VID
<i>Ipv4-address</i>	Ipv4 Ip
<i>Ipv6-address</i>	Ipv6 Ip

└───

└───

└───

```

1      192.168.1.100      10
Ruijie(config)# switchport port-security binding interface g0/10
192.168.1.100
2      192.168.1.100 MAC      00d0.f800.5555, VID= 1      10
Ruijie(config)# switchport port-security binding interface g0/10 00d0.f800.5555
vlan 1 192.168.1.100

```

	switchport port-security	
	switchport port-security binding	
	Switchport port-security mac-address	
	switchport port-security aging	
	show port-security	



1 TRUNK 10

```
1      TRUNK    10          00d0.f800.5555 VID=2
Ruijie(config)#  switchport  port-security  interface  g0/10
mac-address 00d0.f800.5555 vlan 2
```

```

Interface Broadcast Control Multicast Control Unicast Control
-----
Gi1/1 Disabled Disabled Disabled

```

.storm-control	

-	-

28.2.2 show port-security

show port-security [*address*] [*interface interface-id*] [*all*]

address	
interface <i>interface-id</i>	
all	

```

Ruijie# show port-security
Secure Port MaxSecureAddr(count) CurrentAddr(count) Security
Action
-----
Gi1/1 128 1 Restrict
Gi1/2 128 0 Restrict
Gi1/3 8 1 Protect

```

	switchport port-security	
	switchport port-security aging	
	switchport port-security mac-address	

	-	-

29 802.1X

29.1 dot1x

29.1.1 dot1x auto-req

802.1X

dot1x auto-req

no

[no] dot1x auto-req

-	-

29.1.3 dot1x auto-req req-interval

no

dot1x auto-req req-interval *interval*

no dot1x auto-req req-interval

<i>interval</i>	s

30

show dot1x auto-req

```

802.1x          60s
Ruijie# configure terminal
Ruijie(config)# dot1x auto-req req-interval 60
Ruijie(config)# end
Ruijie# show dot1x auto-req
Auto-Req: Enabled
User-Detect : Enabled
Packet-Num  : 0
Req-Interval: 60 Second
    
```

show dot1x auto-req	

-	-

29.1.4 dot1x auto-req user-detect

no

dot1x auto-req user-detect

no dot1x auto-req user-detect

-	-

show dot1x auto-req

```
Ruijie# configure terminal
Ruijie(config)# dot1x auto-req user-detect
Ruijie(config)# end
Ruijie# show dot1x auto-req
Auto-Req: Enabled
User-Detect : Enabled
Packet-Num : 0
Req-Interval: 60 Second
```

show dot1x auto-req	

• 5BË† <Â Â)pÁ— Ä — e, ñvXI p Bá— Ä. t%# 1wBR0 p BrB6)pÁvX(T0e1T'4@ t%"™ 0`...!AbrB", N

29.2 dot1x

29.2.1 dot1x timeout quiet-period

no

dot1x timeout quiet-period *seconds*

no dot1x timeout quiet-period

<i>seconds</i>	0 65535 s

10

show dot1x

```

1000s
Ruijie# configure terminal
Ruijie(config)# dot1x timeout quiet-period 1000
Ruijie(config)# end
Ruijie# show dot1x
802.1X Status:      Enabled
Authentication Mode: EAP-MD5
Authed User Number: 0
Re-authen Enabled: Disabled
Re-authen Period:  3600 sec
Quiet Timer Period: 1000 sec
Tx Timer Period:   3 sec
Supplicant Timeout: 3 sec
Server Timeout:    5 sec
Re-authen Max:     3 times
Maximum Request:   3 times
Filter Non-RG Supp: Disabled

```

```

Client Oline Probe: Disabled
Eapol Tag Enable: Disabled
Authorization Mode: Group Server

```

show dot1x	802.1x

-	-

29.2.2 dot1x timeout re-authperiod

no

dot1x timeout re-authperiod *seconds*

no dot1x timeout re-authperiod

<i>seconds</i>	0 65535 s

3600

show dot1x 802.1x

1000s

```

Ruijie# configure terminal
Ruijie(config)# dot1x timeout re-authperiod 1000
Ruijie(config)# end
Ruijie# show dot1x
802.1X Status: Enabled
Authentication Mode: EAP-MD5
Authed User Number: 0
Re-authen Enabled: Disabled

```

Re-authen Period: 1000 sec
Quiet Timer Period: 1000 sec
Tx Timer Period: 3 sec
Supplicant Timeout: 3 sec
Server Timeout: 5 sec
Re-authen Max: 3 times
Maximum 2Request: 3 times
Filter Non-RG Supp: Disabled
Client Oline Probe: Disabled
Eapol Tag Enable: Disabled
Authorization Mode: Group Server



-	-
---	---

29.2.5 dot1x timeout tx-period

no

dot1x timeout tx-period *seconds*

no dot1x timeout tx-period

<i>seconds</i>	0 65535

3

show dot1x 802.1x

10s

```
Ruijie# configure terminal
Ruijie(config)# dot1x timeout tx-period 10
Ruijie(config)# end
Ruijie# show dot1x
802.1X Status:      Enabled
Authentication Mode: EAP-MD5
Authed User Number: 0
Re-authen Enabled:  Disabled
Re-authen Period:   1000 sec
Quiet Timer Period: 1000 sec
Tx Timer Period:    10 sec
Supplicant Timeout: 10 sec
Server Timeout:     10 sec
Re-authen Max:      3 times
Maximum Request:    3 times
Filter Non-RG Supp: Disabled
Client Oline Probe: Disabled
Eapol Tag Enable:   Disabled
```

Authorization Mode: Group Server



```

Re-authen Period:    1000 sec
Quiet Timer Period:  1000 sec
Tx Timer Period:     10 sec
Supplicant Timeout:  10 sec
Server Timeout:      10 sec
Re-authen Max:       3 times
Maximum Request:     3 times
Filter Non-RG Supp:  Disabled
Client Oline Probe:  Disabled
Eapol Tag Enable:    Disabled
Authorization Mode:   Group Server

```

show dot1x	802.1x

-	-

29.3.2 dot1x reauth-max

no

dot1x reauth-max *count*

no dot1x reauth-max

<i>count</i>	

3

show dot1x

802.1x

```

Ruijie# configure terminal
Ruijie(config)# dot1x reauth-max 5
Ruijie(config)# end
Ruijie# show dot1x
802.1X Status:          Enabled
Authentication Mode:    EAP-MD5
Authed User Number:     0
Re-authen Enabled:     Enabled
Re-authen Period:      1000 sec
Quiet Timer Period:    1000 sec
Tx Timer Period:        10 sec
Supplicant Timeout:    10 sec
Server Timeout:         10 sec
Re-authen Max:          5 times
Maximum Request:        3 times
Filter Non-RG Supp:     Disabled
Client Oline Probe:     Disabled
Eapol Tag Enable:       Disabled
Authorization Mode:     Group Server

```

show dot1x	802.1x

-	-

29.4 dot1x

29.4.1 dot1x probe-timer

dot1x probe-timer{interval | alive}*interval*

no dot1x probe-timer

no	
<i>interval</i>	hello
alive	
interval	

```
Hello          20
                250
```

show dot1x 802.1x

```
hello          30 ,          120
Ruijie# configure terminal
Ruijie(config)# dot1x probe-timer interval 30
Ruijie(config)# dot1x probe-timer alive 120
Ruijie(config)# end
Ruijie# show dot1x probe-timer
Hello Interval: 30 Seconds
Hello Alive: 120 Seconds
```

Show dot1x probe-timer	
-------------------------------	--



	-	-
--	---	---

--	--	--

--	--	--

--	--	--

```
Ruijie# configure terminal
Ruijie(config)# dot1x client-probe enable
Ruijie(config)# end
Ruijie# show dot1x
802.1X Status:      Enabled
Authentication Mode: EAP-MD5
Authed User Number: 0
Re-authen Enabled:  Enabled
Re-authen Period:  1000 sec
Quiet Timer Period: 1000 sec
Tx Timer Period:   10 sec
Supplicant Timeout: 10 sec
Server Timeout:   10 sec
```

29.5 dot1x

29.5.1 dot1x authentication

AAA

AAA

no**dot1x authentication** {default | *list-name*}**no dot1x authentication** {default | *list-name*}

|



29.5.2 dot1x auth-address-table

802.1X

no

dot1x auth-address-table address *mac-addr* **interface** *interface*

no dot1x auth-address-table address *mac-addr* **interface** *interface*

<i>mac-addr</i>	
<i>Interface</i>	

┌

┌

┌

802.1X

show dot1x auth-address

table

┌

```
Ruijie# configure terminal
Ruijie(config)# dot1x auth-address-table address
00d0f8000000 interface ethernet 1/1
Ruijie(config)# end
Ruijie#
```

┌

show dot1x auth-address-table	802.1X

┌

┌

-	-

29.5.3 dot1x auth-mode

802.1x

dot1x auth-mode {eap-md5 | chap | pap}

no dot1x auth-mode

eap-md5	802.1x	EAP-MD5
chap	802.1x	CHAP
pap	802.1x	PAP

EAP-MD5

show dot1x 802.1x

802.1x

```
Ruijie# configure terminal
Ruijie(config)# dot1x auth-mode chap
Ruijie(config)# end
Ruijie#
```

show dot1x	802.1x

show dot1x 802.1x

802.1x

```
Ruijie# configure terminal  
Ruijie(config)# dot1x default  
Ruijie(config)# end  
Ruijie# end
```

show dot1x

802.1x

```
Ruijie(config)# dot1x dynamic-vlan enable
Ruijie(config)# end
Ruijie#
```

show dot1x	802.1x

-	-

29.5.6 dot1x guest-vlan

```

      guest vlan          no
dot1x dynamic-vlan <1 - 4094>
no dot1x guest-vlan

```

vid	<1 - 4094>

```

      guest vlan          dot1x dynamic-vlan enable
      guest vlan
      guest vlan
      vlan
      show running-config      802.1x

```

```

      802.1x guest vlan
Ruijie# configure terminal
Ruijie(config)# dot1x guest-vlan 10
Ruijie(config)# end
Ruijie#
```

	show running-config	802.1x

|

	-	-

29.5.7 dot1x eapol-tag

EAPOL TAG

dot1x eapol-tag

no dot1x eapol-tag

	-	-

|

|

|

show dot1x 802.1x

|

802.1X tag

```
Ruijie# configure terminal
Ruijie(config)# dot1x eapol-tag
Ruijie(config)# end
Ruijie#
```

|

show dot1x		802.1x

|

|

	-	-

29.5.8 dot1x max-req

DOT1X

DOT1X

DOT1X

no

dot1x max-req *count*

no dot1x max-req



```

show dot1x private-supPLICant-only      802.1x

```

```

Ruijie# configure t
Ruijie(config)# dot1x private-supPLICant-only
Ruijie(config)# end
Ruijie#

```

show dot1x private-supPLICant-only	

-	-

29.5.10 dot1x port-control auto

no

dot1x port-control auto

no dot1x port-control

no2_0 1 T5/TT0 1 0.0803 5/TT0 1 0.0803 5TjETq/TT1 1 5TjETq/TT1 1 5 328.280.52 I55 328.280.52 I55

```
Ruijie#
```

show dot1x	802.1x

-	-

29.5.11 dot1x port-control-mode

802.1x

MAC

dot1x port-control-mode {mac-based | {port-based [single-host]} }

no dot1x port-control-mode

mac-based	mac 802.1X
port-based	802.1X
single-host	802.1x

```
mac-based
```

```
show dot1x port-control 802.1x
single-host
```

```

1          802.1x
Ruijie(config)# interface g 0/1
Ruijie(config-if)# dot1x port-control auto
Ruijie(config-if)# dot1x port-control-mode port-based
Ruijie(config-if)# end
Ruijie#

2          802.1x
Ruijie(config)# interface g 0/1
Ruijie(config-if)# dot1x port-control auto
Ruijie(config-if)# dot1x port-control-mode port-based single-host
Ruijie(config-if)# end
Ruijie#

```

show dot1x port-control	802.1x
Show running-config	

-	-

29.5.12 dot1x stationarity enable

802.1x

802.1X

dot1x stationarity enable**no dot1x stationarity enable**

-	-

```

┌
└

```

```

┌
└

```

```

802.1x
Ruijie# configure terminal
Ruijie(config)# dot1x stationarity enable
Ruijie(config)# end
Ruijie#

```

```

┌
└

```

-	-

```

┌
└

```

```

┌
└

```

-	-

29.5.13 dot1x redirect url

```

802.1x
URL          URL    http://
http://ruijie.net/web  http://  https://
url          url    no
url

```

dot1x redirect url [*url-string*]

[no] dot1x redirect url

```

┌
└

```

<i>url-string</i>	URL

```

┌
└

```

```

┌
└

```

```

┌
└

```

```

┌
└

```

```

1          ruijie.net/web
Ruijie(config)# dot1x redirect url http://ruijie.net/web

```

dot1x redirect for special tcp-destination port	ip ip web
dot1x redirect time-out	
dot1x redirect num for special source-ip	
show dot1x	dot1x

┌

-	-

29.5.14 dot1x redirect for special tcp-destination port

```

port          16      TCP      ip      ip      web      80 8080
              no dot1x redirect for special tcp-destination
              port_num
    
```

[no] dot1x redirect for special tcp-destination port *port num*

<i>port num</i>	TCP

┌

```

tcp      80 8080      no
    
```

┌

```

TCP      1-65535
    
```

┌

```

1      TCP      8443
Ruijie(config)#dot1x redirect for special tcp-destination port
8443
    
```

dot1x redirect url	

dot1x redirect time-out	
dot1x redirect num for special source-ip	
show dot1x	dot1x
-	-

29.5.15 dot1x redirect time-out

(), 3 1-10 no

dot1x redirect time-out port *time-out-interval*

no dot1x redirect time-out port

<i>time-out-interval</i>	

3

1

5

Ruijie(config)# **dot1x redirect time-out** 5

dot1x redirect url	web ip ip
dot1x redirect for special tcp-destination port	
dot1x redirect num for special source-ip	

show dot1x

dot1x

-	-

29.6 dot1x

29.6.1 show dot1x

802.1x

show dot1x

-	-

└───┘

└───┘

└───┘

```
Ruijie# show dot1x
802.1X Status:      Enabled
Authentication Mode: EAP-MD5
Authed User Number: 0
Re-authen Enabled: Disabled
Re-authen Period:  3600 sec
Quiet Timer Period: 10 sec
Tx Timer Period:   3 sec
Supplicant Timeout: 3 sec
Server Timeout:    5 sec
Re-authen Max:     3 times
Maximum Request:   3 times
Filter Non-RG Supp: Disabled
Client Oline Probe: Disabled
Eapol Tag Enable:  Disabled
Authorization Mode: Group Server
Ruijie#
```

dot1x auth-mode	802.1x
dot1x max-req	
dot1x port-control auto	
dot1x reauth-max	
dot1x re-authentication	
dot1x timeout quiet-period	
dot1x timeout re-authperiod	
dot1x timeout server-timeout	
dot1x timeout supp-timeout	
dot1x timeout tx-period	



```
Ruijie# show dot1x auth-address-table
interface:g3/1
-----
mac addr: 00D0.F800.0001
Ruijie#
```

--	--

dot1x auth-mode

-	-

```
Ruijie# show dot1x auto-req
Auto-Req: Disabled
User-Detect : Enabled
Packet-Num : 0
Req-Interval: 30 Seconds
```

dot1x auth-mode	802.1x
dot1x max-req	
dot1x port-control auto	
dot1x reauth-max	
dot1x re-authentication	
dot1x timeout quiet-period	
dot1x timeout re-authperiod	
dot1x timeout server-timeout	
dot1x timeout supp-timeout	
dot1x timeout tx-period	

-	-

29.6.4 show dot1x private-supPLICANT-only

show dot1x private-supPLICANT-only

-	-

┌

┌

┌

```
Ruijie# show dot1x private-supPLICANT-only
private-supPLICANT-only:: disabled
Ruijie#
```

dot1x auth-mode	802.1x
dot1x max-req	
dot1x port-control auto	
dot1x reauth-max	
dot1x re-authentication	
dot1x timeout quiet-period	
dot1x timeout re-authperiod	
dot1x timeout server-timeout	
dot1x timeout supp-timeout	
dot1x timeout tx-period	

└──

└──

-	-

29.6.5 show dot1x max-req

show dot1x max-req

-	-

└───┘

└───┘

└───┘

```
Ruijie# show dot1x max-req
max-req: 2 times
Ruijie#
```

dot1x auth-mode	802.1x
dot1x max-req	
dot1x port-control auto	
dot1x reauth-max	
dot1x re-authentication	
dot1x timeout quiet-period	
dot1x timeout re-authperiod	
dot1x timeout server-timeout	
dot1x timeout supp-timeout	
dot1x timeout tx-period	

└───┘

	-	-

29.6.6 show dot1x port-control

show dot1x port-control [interface *interface*]

	<i>interface</i>	

└───

└───

└───

	dot1x timeout server-timeout	
	dot1x timeout supp-timeout	
	dot1x timeout tx-period	

```
Ruijie# show dot1x reauth-max
reauth-max: 2 times
Ruijie#
```

dot1x auth-mode	802.1x
dot1x max-req	
dot1x port-control auto	
dot1x reauth-max	
dot1x re-authentication	
dot1x timeout quiet-period	
dot1x timeout re-authperiod	
dot1x timeout server-timeout	
dot1x timeout supp-timeout	
dot1x timeout tx-period	

-	-

29.6.10 show dot1x summary

802.1X

show dot1x summary

-	-

```

Ruijie# show dot1x summary
ID      MAC          Interface VLAN Auth-State
Backend-State Port-Status Type
-----
1 00d0f8000000 Gi0/1      1 Authenticated Idle
Authed   Static
Ruijie#
    
```

dot1x auth-mode	802.1x
dot1x max-req	
dot1x port-control auto	
dot1x reauth-max	
dot1x re-authentication	
dot1x timeout quiet-period	
dot1x timeout re-authperiod	
dot1x timeout server-timeout	
dot1x timeout supp-timeout	
dot1x timeout tx-period	

-	-
---	---

29.6.11 show dot1x user id

802.1X

show dot1x user id *<id>*

--	--

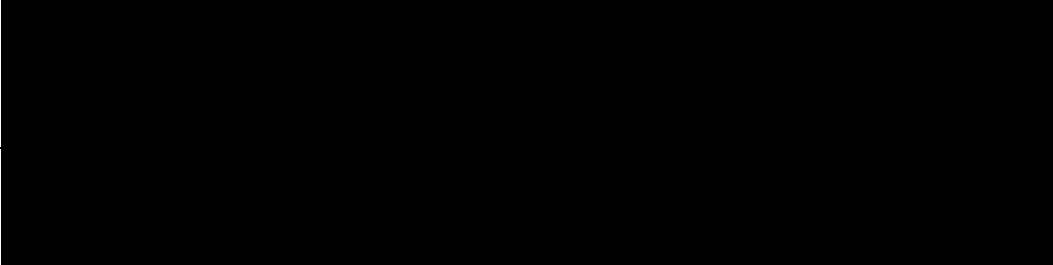

dot1x port-control auto

dot1xTd2[(do68>6<D5re386.02 473.58 0.72 refB/TT0 1 Tf-0.0028 Tc 9 61.6e(th6e(-418A>6<09960

```
Ruijie# show dot1x timeout quiet-period
quiet-period: 60 sec
Ruijie#
```

dot1x auth-mode	802.1x
dot1x max-req	
dot1x port-control auto	
dot1x reauth-max	
dot1x re-authentication	

```
dot1x timeo/Tpf-0.0024 Tw 1.198 <4-0.0024 Tw 1.] 0.47A48 20.1 33.36 394.9840.1 F909E20804
```

30 AAA

30.1

30.1.1 aaa authentication dot1x

AAA 802.1X

aaa authentication dot1x

aaa new-model	AAA
dot1x authentication	802.1X
username	

AAA Enable

RADIUS

RADIUS

Ruijie(config)# **aaa authentication enable default group radius local**

|
|

```
AAA AAA Login  
aaa authentication login Login  
Login Login
```

```
list-1 AAA Login  
RADIUS RADIUS  
Ruijie(config)# aaa authentication login list-1 group radius local
```

aaa new-model	AAA
username	
login authentication	Login

|
|

--	--

local	
none	
group	TACACS+ RADIUS

AAA PPP AAA PPP
aaa authentication ppp PPP

rds_ppp AAA PPP
RADIUS RADIUS

Ruijie(config)# **aaa authentication ppp** *rds_ppp*

default	Login
<i>list-name</i>	Login

```

Login
Login
                                Login
                                Login
                                Login

```

```

list-1 AAA Login
VTY 0 - 4
Ruijie(config)# aaa authentication login list-1 local
Ruijie(config)# line vty 0 4
Ruijie(config-line)# login authentication list-1

```

aaa new-model	AAA
username	
login authentication	Login

-	-
---	---

30.2

30.2.1 aaa authorization commands

	NAS	CLI	AAA	aaa authorization
commands		no	AAA	
aaa authorization commands	<i>level</i>	{ default <i>list-name</i> }	<i>method1</i>	[<i>method2...</i>]

no aaa authorization commands *level* {**default** | *list-name*}

<i>level</i>	0~15
default	Q

	-	-

RGOS

Ruijie(config)# **aaa authorization console**

aaa new-model	AAA	AAA
----------------------	-----	-----

AAA

default	Network
<i>method</i>	" none group" 4
none	
group	TACACS+ RADIUS

AAA Network

RGOS

PPP SLIP

RADIUS TACACS+

RADIUS

Ruijie(config)# **aaa authorization network default group radius**

aaa new-model	AAA
aaa accounting	AAA
aaa authentication	AAA C"!Ft#;8@H1P#"B2B ah'CAZP

authorization**commands** no**authorization commands** *level* {**default** | *list-name*}**no authorization commands** *level*

<i>level</i>	0~15
default	
<i>list-name</i>	

AAA

cmd

15

TACACS+

none

VTY 0-4

Ruijie(config)# **aaa authorization commands 15 cmd group tacacs+ none**Ruijie(config)# **line vty 0 4**Ruijie(config-line)# **authorization commands 15 cmd**

aaa new-model	AAA
aaa authorization commands	AAA

-	-

30.2.7 authorization exec

Exec

authorization exec

no

Exec

authorization exec {default | list-name}**no authorization exec**

default	Exec
<i>list-name</i>	Exec

AAA Exec

Exec

Exec

Exec

Exec

exec-1 Exec

RADIUS

none

VTY 0 – 4

Ruijie(config)# **aaa authorization exec exec-1 group radius none**Ruijie(config)# **line vty 0 4**Ruijie(config-line)# **authorization exec exec-1**

aaa new-model	AAA
aaa authorization commands	AAA Exec

-	-

30.3

30.3.1 aaa accounting commands

NAS

aaa accounting commands no

aaa accounting commands *level* {**default** | *list-name*} **start-stop** *method1* [*method2...*]

no aaa accounting commands *level* {**default** | *list-name*}

<i>level</i>	0~15
default	
<i>list-name</i>	
<i>method</i>	" none group" 4
none	
group	TACACS+

RGOS

aaa new-model	AAA
aaa authentication	AAA
accounting commands	Exec
-	-

30.3.3 aaa accounting network

aaa accounting network no

aaa accounting network {default | *list-name*} **start-stop** *method1* [*method2*...]

no aaa accounting network {default | *list-name*}

default	Network
<i>list-name</i>	
start-stop	
<i>method</i>	4
none	
group	RADIUS @radius

```
Ruijie(config)# aaa accounting network default start-stop group radius
```

aaa new-model	AAA
aaa authorization network	AAA
aaa authentication	AAA
username	

-	-
---	---

30.3.4 aaa accounting update

aaa accounting update

no

aaa accounting update

no aaa accounting update

-	-
---	---

AAA

AAA

```
Ruijie(config)# aaa new-model
```

```
Ruijie(config)#
```

--	--

	aaa new-model	AAA
	aaa accounting network	

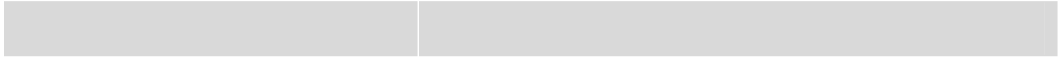

-	-

30.3.6 accounting commands

accounting commands

no

accounting commands *level* {**default** | *list-name*}

no accounting commands *level*

<i>level</i>	0~15
default	
<i>list-name</i>	

└──

└──

└──

cmd

15

TACACS+

none

VTY 0-4

```
Ruijie(config)# aaa accounting commands 15 cmd group tacacs+ none
```

```
Ruijie(config)# line vty 0 4
```

```
Ruijie(config-line)# accounting commands 15 cmd
```

aaa new-model	AAA
aaa accounting commands	AAA

└──

-	-

30.3.7 accounting exec

Exec

no

Exec

accounting exec

accounting exec {default | *list-name*}

no accounting exec

default	Exec
<i>list-name</i>	Exec

└──

└──

└──

Exec
Exec

Exec

Exec

exec-1 Exec
none

RADIUS
VTY 0 – 4

Ruijie(config)# **aaa accounting exec exec-1 group radius none**

Ruijie(config)# **line vty 0 4**

Ruijie(config-line)# **accounting exec exec-1**

aaa new-model	AAA
aaa accounting commands	AAA Exec

└──

└──

--	--

-	-
---	---

30.4 AAA

30.4.1 aaa domain

no

aaa domain {**default** | *domain-name*}

no aaa domain {**default** | *domain-name*}

default	
<i>domain-name</i>	

--

--

--

AAA **default**
domain-name

32

--

```
Ruijie(config)# aaa domain ruijie.com
Ruijie(config-aaa-domain)#
```

aaa new-model	AAA
aaa domain enable	AAA
show aaa domain	

--

-	-

30.4.2 aaa domain enable

AAA
AAA no

aaa domain enable

no aaa domain enable

	-	-

┌
└

AAA

┌
└

AAA

┌
└

AAA
Ruijie(config)# **aaa domain enable**

aaa new-model		AAA
show aaa domain		

┌
└

	-	-

30.4.3 access-limit

IEEE802.1x no

access-limit *num*

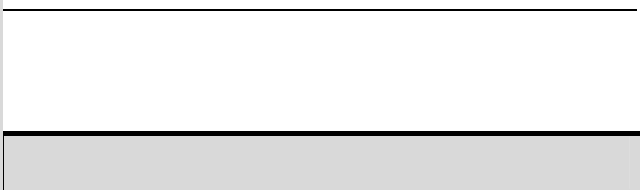

“



default

Network

Network

Ruijie(config)# **aaa domain ruijie.com**

Ruijie(config-aaa-domain)# **accounting network default**

aaa new-model	AAA
aaa domain enable	AAA
show aaa domain	

-	-

30.4.5 authentication dot1x

IEEE802.1x

no

authentication dot1x {default | list-name}

no authentication dot1x

default	
<i>list-name</i>	

default

```
IEEE802.1x
```

```
IEEE802.1x
```

```
Ruijie(config)# aaa domain ruijie.com
```

```
Ruijie(config-aaa-domain)# authentication dot1x default
```

aaa new-model	AAA
aaa domain enable	AAA
show aaa domain	

-	-

30.4.6 authorization network

```
Network no
```

```
authorization network {default | list-name}
```

```
no authorization network
```

default	
<i>list-name</i>	

```
default
```

```
Ruijie(config)# aaa domain ruijie.com
```

```
Ruijie(config-aaa-domain)# authorization network default
```



aaa new-model	AAA
aaa domain enable	AAA
show aaa domain	

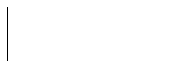

-	-

30.4.8 show aaa domain

show aaa domain [default6

	aaa new-model	AAA
	aaa domain enable	AAA
	-	-

30.4.9 username-format

NAS

no

username-format {without-domain | with-domain}

no username-format

NO3C-wR0-VH5%ãT V2bL8jgbY\$H AH dD7\$Cxx0i,06B@hdq%-FwN0x5,00-m9/@H4bDc8\$%-BN

-	-

30.5 AAA

30.5.1 aaa group server

AAA no

aaa group server {radius | tacacs+} name

no aaa group server {radius | tacacs+} name

<i>name</i>	" radius" " tacacs+" RADIUS TACACS+

┌

┌

┌

AAA RADIUS TACACS+

┌

```
Ruijie(config)# aaa group server radius ss
```

```
Ruijie(config-gs-radius)# end
```

```
Ruijie# show aaa group
```

```
Group Name:  ss
```

```
Group Type:  radius
```

```
Referred:    1
```

```
Server List:
```

show aaa group	aaa

┌

	-	-

30.5.2 ip vrf forwarding

AAA vrf no

ip vrf forwarding *vrf_name*

no ip vrf forwarding

	<i>vrf_name</i>	vrf

└──

└──

└──

vrf

```
Ruijie(config)# aaa group server radius ss
Ruijie(config-gs-radius)# server 192.168.4.12
Ruijie(config-gs-radius)# server 192.168.4.13
Ruijie(config-gs-radius)# ip vrf forwarding vrf_name
Ruijie(config-gs-radius)# end
```

	aaa group server	aaa
	show aaa group	aaa

└──

	-	-

30.5.3 server

AAA no

server ip-addr [authen-port port1] [acct-port port2]

no server ip-addr [authen-port port1] [acct-port port2]

<i>ip-addr</i>	ip
<i>port1</i>	RADIUS
<i>port2</i>	RADIUS

```
Ruijie(config)# aaa group server radius ss
Ruijie(config-gs-radius)# server 192.168.4.12
acct-port 5 authen-port 6
Ruijie(config-gs-radius)# end
Ruijie# show aaa group
Group Name: ss
Group Type: radius
Referred: 2
Server List:
IP Address: 192.168.4.12
Authentication Port: 6
Accounting Port: 5
Referred: 1
```

aaa group server	aaa
show aaa group	aaa

AAA

	-	-
--	---	---

30.5.4 show aaa group

AAA

show aaa group

	-	-

|

|

|

AAA

|

```
Ruijie# show aaa group
Group Name:  ss
Group Type:  radius
Referred:    2
Server List:
IP Address:  192.168.217.64
Authentication Port: 1812
Accounting Port: 1813
Referred:    1
```

|

	aaa group server	AAA

|

|

	-	-

30.6 AAA

Local authentication attempts

Local authentication attempts *max-attempts*

<i>max-attempts</i>	1~2147483647

3

Login

```
Ruijie# configure terminal
```

```
Ruijie(config)# aaa local authentication attempts 6
```

|

| login

|

Ruijie# **configure terminal**
 Ruijie(config)# **aaa local authentication lockout-time 5**

|

Show running-config	
Show aaa lockout	login

|

|

-	-

30.6.3 aaa new-model

RGOS AAA **aaa new-model** AAA
 no AAA

aaa new-model

no aaa new-model

|

-	-

| AAA

|

|

AAA AAA **aaa new-model**
 AAA AAA AAA

|

AAA
 Ruijie(config)# **aaa new-model**

	aaa authentication	
	aaa accounting	

	-	-

30.6.4 clear aaa local user lockout

30.6.5 debug aaa

AAA

no

debug aaa event**no debug aaa event**

	-	-

--

EXEC

--

--

	-	-

--

	-	-

30.6.6 show aaa method-list

AAA

show aaa method-list

	-	-

AAA

AAA

```

Ruijie# show aaa method-list
Authentication method-list
aaa authentication login default group radius
aaa authentication ppp default group radius
aaa authentication dot1x default group radius
aaa authentication dot1x san-f local group angel group rain none
aaa authentication enable default group radius
Accounting method-list
aaa accounting network default start-stop group radius
Authorization method-list
aaa authorizing network default group radius

```

aaa authentication	
aaa authorization	
aaa accounting	

-	-

30.6.7 show aaa user lockout

show aaa user lockout {all | user-name <word>}

<word>	ID

|

|

Ruijie# **show aaa user lockout all**

|

show running-config	
show aaa lockout	login

|

|

-	-

31.1.2 radius attribute

radius ttribute{<id> | **down-rate-limit** | **dscp** | **mac-limit** | **up-rate-limit**} **vendor-type**
<type>

no radius attribute {<id>|**down-rate-limit** | **dscp** | **mac-limit** | **up-rate-limit**} **vendor-type**

<i>id</i>	id <1-255>
<i>type</i>	type

id		type
1	max down-rate	1
2	qos	2
3	user ip	3
4	vlan id	4
5	version to client	5
6	net ip	6
7	user name	7
8	password	8
9	file-diractory	9
10	file-count	10
11	file-name-0	11
12	file-name-1	12
13	file-name-2	13
14	file-name-3	14
15	file-name-4	15
16	max up-rate	16
17	version to server	17
18	flux-max-high32	18
19	flux-max-low32	19
20	proxy-avoid	20
21	dailup-avoid	21
22	ip privilege	22

23	login privile	42
----	---------------	----

radius-server key	RADIUS
radius-server retransmit	RADIUS

RADIUS

	-	-

31.1.6 radius-server retransmit

RADIUS

radius-server retransmit no

radius-server retransmit *retries*

no radius-server retransmit

	<i>retries</i>	RADIUS

3

AAA

€

RADIUS

radius-server timeout no

radius-server timeout *seconds*

no radius-server timeout

<i>seconds</i>		1-1000

5

10
 Ruijie(config)# **radius-server timeout 10**

radius-server host		RADIUS
radius-server retransmit		RADIUS
radius-server key		RADIUS

-		-

31.1.8 radius set qos cos

radius qos cos

radius set qos cos

no radius set qos cos

-		-

┌

qos dscp

┌

┌

qos cos dscp

┌

Ruijie(config)# radius set qos cos

┌

radius vendor-specific extend	Radius	id	

┌

┌

-		-	

31.1.9 radius vendor-specific extend

id

radius vendor-specific extend

no radius vendor-specific extend

┌

-		-	

┌

id

┌

┌

id

┌

Ruijie(config)# radius vendor-specific extend

┌

--	--	--	--

/GS0 gsBT/C2_0 1 Tf0 Tc 0 Tw 0 Ts 100 Tz 0 Tr 9 0 0 9 62.34 790.4003 Tm<47213542>Tj/TT0 1 Tf-0.0006 Tc 2.24!*S



RADIUS

show radius parameter

-	-

|

|

|

radius

|

```
Ruijie# show radius parameter
Server Timeout: 5 Seconds
Server Deadtime: 5 Minutes
Server Retries: 3
Server Key: *****
```

|

radius-server host	RADIUS
radius-server retransmit	RADIUS
radius-server key	RADIUS
radius-server timeout	RADIUS

|

|

-	-

└───

└───

└───

radius

Ruijie# **show radius server**

server ip : 192.168.4.12

acct port: 23

authen port: 77

server state: ready

server ip : 192.168.4.13

acct port: 45

authen port: 74

server state: ready

radius-server host	RADIUS
radius-server retransmit	RADIUS

radius-server key Tw 1.198 -0.012 Td[(radius-serv)11(e)-1(r retran)6(smit)]TC2_0 1 Tf0 Tc 0 Tw

radius

```
Ruijie# show radius vendor-specific
id   vendor-specific      type-value
-----
 1   max down-rate        76
 2   qos                  77
 3   user ip              3
 4   vlan id              4
 5   version to client    5
 6   net ip               6
 7   user name            7
 8   password             8
 9   file-diractory      9
10   file-count           10
11   file-name-0          11
12   file-name-1          12
13   file-name-2          13
14   file-name-3          14
15   file-name-4          15
16   max up-rate          75
17   version to server    17
18   flux-max-high32      18
19   flux-max-low32       19
20   proxy-avoid          20
21   dailup-avoid         21
22   ip privilige         22
23   login privilige      42
24   limit to user number 50
```

RADIUS

L

L

-	-

32 TACACS+

32.1 TACACS+

32.1.1 aaa group server tacacs+

TACACS+

TACACS+

```
aaa group server tacacs+ group-name
```

```
no aaa group server tacacs+ group-name
```

	<i>group-name</i>	TACACS+

```
TACACS+
```

```
TACACS+
```

```

tac1 TACACS+ 1.1.1.1
TACACS+
Ruijie(config)# aaa group server tacacs+ tac1
Ruijie(config-gs-tacacs)# server 1.1.1.1
```

server	TACACS+	server
ip vrf forwarding	TACACS+	VRF

-		-

32.1.2 ip tacacs source-interface

TACACS+

ip tacacs source-interface *interface*

no ip tacacs source-interface



Interface

<i>vrf-name</i>	vrf
-----------------	-----

TACACS+

TACACS+ vrf

TACACS+ VRF vpn1

Ruijie(config)# **aaa group server tacacs+ tac1**

Ruijie(config-gs-radius)# **server 1.1.1.1**

Ruijie(config-gs-radius)# **ip vrf forwarding vpn1**

aaa group server tacacs+	TACACS+
server	TACACS+ server

-	-

r(TACACS+)

TACACS+

ip-address | ipv6-address}

er {ip-address | ipv6-address}



```
TACACS+
host
```

aaa group server tacacs+

```
TACACS+
tacacs-server
```

```
TACACS+
tac1 TACACS+ 1.1.1.1
```

```
TACACS+
Ruijie(config)# aaa group server tacacs+ tac1
Ruijie(config-gs-tacacs+)# server 1.1.1.1
```



|

|

TACACS+ AAA TACACS+
tacacs-server TACACS+

|

TACACS+
Ruijie(config)# **tacacs-server host** 192.168.12.1
Ruijie(config)# **tacacs-server host** 2001::1

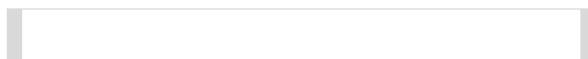

	key	host	key
	TACACS+	aaa	
	Ruijie(config)# tacacs-server key aaa		
	tacacs-server host	TACACS+	
	tacacs-server timeout	TACACS+	
	-	-	

32.1.7 tacacs-server timeout

	TACACS+
	tacacs-server timeout <i>seconds</i>
	no tacacs-server timeout
	<i>seconds</i>
	1-1000
	5
	host
	timeout
	timeout
	10
	Ruijie(config)# tacacs-server timeout 10

tacacs-server host	TACACS+
tacacs-server key	TACACS+

	-	

32.2 TACACS+

32.2.1 debug tacacs+

TACACS+ no TACACS+

debug tacacs+

no debug tacacs+

--	--

32.2.2 show tacacs

TACACS+

show tacacs

33 SSH

33.1 SSH

33.1.1 crypto key generate

crypto key generate {rsa | dsa}

rsa	RSA
dsa	DSA

SSH Server

SSH Server

SSH

enable service ssh-server

SSH Server

SSH 1

RSA

SSH

2 RSA DSA

RSA

SSH1

SSH2

DSA

SSH2

no crypto key generate

crypto key zeroize

Ruijie# **configure terminal**

Ruijie(config)# **crypto key generate rsa**

3



SSH Server

SSH Server
no enable service ssh-server

DISABLE



```
Ruijie# configure terminal  
Ruijie(config)# crypto key zeroize rsa
```



┌

┌

SSH Server
120s show ip ssh SSH server

┌

100s
Ruijie# **configure terminal**
Ruijie(config)# **ip ssh time-out 100**

┌

show ip ssh	ssh-server

┌

RGOS10.1

┌

-	-

33.1.5 ip ssh version

SSH server no
ip ssh version {1 / 2} EAe;U#9H7IGDaD\$RGGWADsdqE-82E

2

```
Ruijie# configure terminal  
Ruijie(config)# ip ssh version 2
```

```
show ip ssh
```

```
SSH Server
```

```
RGOS10.1
```

SSH

	Clear line vty <i>line_number</i>	VTY
	RGOS10.1	

show ip ssh

-	-

└───

└───

SSH Server	SSH Server
SSH	

└───

Ruijie# **show ip ssh**

ip ssh version {1 2}	SSH Server
ip ssh time-out time	SSH Server
ip ssh authentication-retries retry times	SSH Server

└───

RGOS10.1

-	-

33.2.4 show ssh

SSH

show ssh

-	-

└───

34 CPU

34.1

34.1.1 cpu-protect cpu bandwidth *bandwidth_value*

CPU

cpu-protect cpu bandwidth *bandwidth_value*

<i>bandwidth_value</i>	64 1000000(kbps)

S2900 CPU 100000kbps

```

CPU 2000 kbps
Ruijie# configure terminal
Ruijie(config)# cpu-protect cpu bandwidth 2000
Ruijie(config)#end
Ruijie# show cpu-protect cpu
%cpu port bandwidth: 2000(kpbs)

```

cpu-protect type packet-type traffic-class <i>traffic-class-num</i>	
cpu-protect traffic-class id <i>id_num</i> bandwidth <i>bandwidth_value</i>	
cpu-protect traffic-class all bandwidth <i>bandwidth_value</i>	

	-	-

34.1.2 cpu-protect mac-address storm-control enable *value*

cpu-protect mac-address storm-control enable *value*

	<i>value</i>	

cpu-protect traffic-class id *id_num* bandwidth *bandwidth_value*

<i>id_num</i>	ID 0 7
<i>bandwidth_value</i>	32 131072(kbps)

S2900 7 100000kbps 1000kbps

```

7 312(kbps)
Ruijie#configure terminal
Ruijie(config)# cpu-protect traffic-class id 7 bandwidth 312
Ruijie(config)#end
Ruijie# show cpu-protect traffic-class id 7
%*****traffic class bandwidth(kbps)*****
7 312
    
```

cpu-protect type packet-type traffic-class <i>traffic-class-num</i>	
cpu-protect traffic-class all bandwidth <i>bandwidth_value</i>	

-	-

34.1.4 cpu-protect traffic-class all bandwidth *bandwidth_value*

cpu-protect traffic-class id *id_num* bandwidth *bandwidth_value*

--	--

bandwidth_

S2900



|

|

-	-

34.2

34.2.1 show cpu-protect cpu

CPU

show cpu-protect cpu

|

-	-

|

|

|

CPU

|

CPU

Ruijie# **show cpu-protect cpu**
%cpu port bandwidth: 100000(kbps)

|

show cpu-protect type <i>packet-type</i>	
show cpu-protect traffic-class id id_num	id_num 0 7
show cpu-protect traffic-class all	

|

|

--	--

	-	-
--	---	---

34.2.2 show cpu-protect traffic-class id id_num

show cpu-protect traffic-class id *id_num*

<i>idt_num</i>		0-7

|

|

|

1 CPU

Ruijie#show cpu-protect traffic-class id 1

%*****traffic class bandwidth(kbps)*****

1000

show cpu-protect type <i>packet-type</i>	
show cpu-protect traffic-class all	
show cpu-protect cpu	CPU

|

-	-

34.2.3 show cpu-protect traffic-class all

show cpu-protect traffic-class all

--	--

-	-
---	---

--

--

--

```

show cpu-protect traffic-class all
Ruijie# show cpu-protect traffic-class all
%*****traffic class      bandwidth(kbps)*****
          0                1000
          1                1000
          2                1000
          3                1000
          4                1000
          5                1000
          6                1000
          7                100000
    
```

show cpu-protect type <i>packet-type</i>	
show cpu-protect traffic-class id id_num	id_num 0 7
show cpu-protect cpu	CPU

--

-	-

34.2.4 show cpu-protect type packet-type

```

show cpu-protect type packet-type

```

--	--

-	-
---	---

show cpu-protect type all

```

%*****packet type          traffic-class*****
      bpdud                   6
      arp                     5
      tpp                     6
      dot1x                   3
      gvrp                    3
      rldp                    6
      dhcpl                   2
      unknown-ipv6-mc         1
      known-ipv6-mc           1
      unknown-ipv4-mc         1
      known-ipv4-mc           1
      udp-helper              0
      dvmrpl                   5
      igmp                    3
      icmp                    5
      ospf                    5
      pim                     5
      rip                     5
      vrrpl                   5
      mld                      3
      ns                      5
      error-ttl               0
      error-hop-limit         0
      local-telnet            5
      local-snmp              5
      local-http              5
      local-tftp              5
      local-other             5
  
```

```

        ipv4-uc          4
        ipv6-uc          4
        other             0
    
```

show cpu-protect traffic-class id <i>id_num</i>	id_num 0 7
show cpu-protect traffic-class all	
show cpu-protect cpu	CPU

```

    
```

-	-

34.2.5 show cpu-protect mac-address storm-control

show cpu-protect mac-address storm-control

-	-

```

    
```

```

    
```

```

    
```

```

        CPU
Ruijie# show cpu-protect mac-address storm-control
%MAC address storm control state: enable
%MAC address storm control rate: 2000(address/second)
    
```

-	-

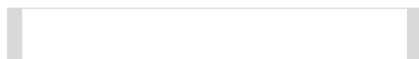

35 GSN

35.1

35.1.1 security address-bind enable

security address-bind enable

no security address-bind enable

		EÄ
	-	-

└───┘

└───┘

└───┘

AP AP

GSN

_N—@m,Äj)DzSe#lâ"ÄfCTnëCqöt5QB25•@< %<(T.\$6h@HaD\$ @ @5

security { [v1 | v2] **community** *community* | v3 **user** *username* }

no security { [v1 | v2] **community** *community* | v3 **user** *username* }

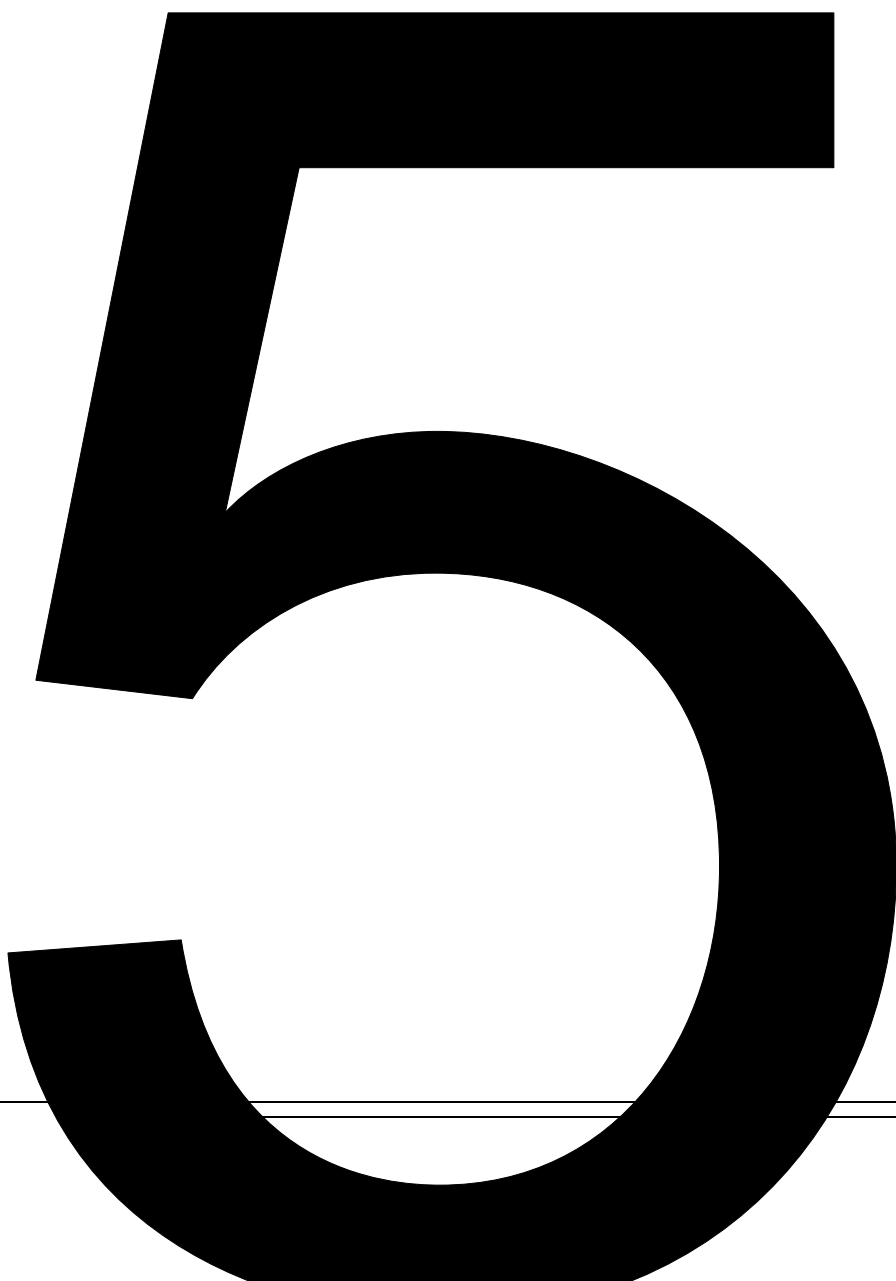
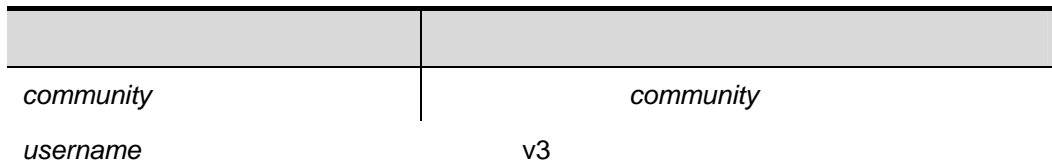

5

show security event interval

Ruijie(config)# **security event interval 10**

[Redacted]	
show security event interval	
[Redacted]	

RGOS10.1

[Redacted]	
-	-
[Redacted]	

35.1.4 security gsn enable

GSN no

security gsn enable

no security gsn enable

[Redacted]	
-	-
[Redacted]	

GSN

GSN

Ruijie# **configure terminal**
Ruijie(config)# **security gsn enable**

[Redacted]	
------------	--

	-	-
	RGOS10.1	
	-	-

35.1.5 smp-server host

smp-server ip

smp-server host *ip-address*

no smp-server host

	<i>ip-address</i>	smp server ip

smp server

show smp-server

Ruijie(config)#**smp-server host** 192.168.4.243

	show smp-server	smp server

RGOS10.1

	-	-

35.2

35.2.1 show security evnet interval

-	-

┌

┌

┌

```
Ruijie# show security event interval
Event sending interval(Seconds):5
```

security event interval <i>interval</i>	

RGOS10.1

-	-

35.2.2 show smp-server

smp server IP

-	-

┌

┌

smp server IP

```
Ruijie# show smp-server
```

SMP-Server IP 192.168.20.30

smp-server host	smp server ip

RGOS10.1

-	-

36 DAI

36.1 VLAN DAI

36.1.1 ip arp inspection vlan

vlan-id VLAN DAI *vlan-id* no VLAN
DAI

ip arp inspection vlan *vlan-id*

no ip arp inspection vlan [*vlan-id*]



36.2

36.2.1 ip arp inspection trust

ip arp inspection trust no

ip arp inspection trust

no ip arp inspection trust

	-	-

┌

┌

ARP	DAI
NFPP(DAI) NFPP show ip arp inspection interface

36.3.1 ip arp inspection limit-rate limit-rate

```

        ARP
        ip arp inspection limit-rate
        no
        ip arp inspection limit-rate {limit-rate | none }
        no ip arp inspection limit-rate
    
```

none	
limit-rate	1 2048

```

        15 ARP / 0
    
```

```

        DAI (Network
        Foundation Protection Policy)
    
```

```

        VLAN 2 gigabitEthernet 0/2 10 ARP
        /
        Ruijie(config)# ip arp inspection
        Ruijie(config)# interface gigabitEthernet 0/2
        Ruijie(config-if)# ip arp inspection limit-rate 10
    
```

-	-

```

        -
    
```

-	-

36.4 DHCP Snooping

```

        VLAN DAI ARP
        ARP DHCP Snooping .
    
```

37 arp

37.1 arp

37.1.1 anti-arp-spoofing ip

arp no

anti-arp-spoofing ip *ip-address*

no anti-arp-spoofing ip *ip-address*

<i>ip-address</i>	IP

show anti-arp-spoofing

```
Ruijie(config)#interface fastEthernet 0/1
Ruijie(config-if)#anti-arp-spoofing ip 192.168.1.1
```

show anti-arp-spoofing	arp

-	-

37.2 arp

37.2.1 show anti-arp-spoofing

arp

show anti-arp-spoofing

|

|

|

```
Ruijie#show anti-arp-spoofing
      port      ip
      -----
      Fa0/1     192.168.1.1
```

anti-arp-spoofing ip	arp

|

-	-

38 IP Source Guard

38.1 IP Source Guard

38.1.1 ip source binding

IP no

[no] ip source binding *mac-address* **vlan** *vlan-id* **ip-address** **interface** *interface-id*



mac-address

show ip source binding		IP
-		-

38.2 IP Source Guard

38.2.1 ip verify source

```

IP Source Guard      no
[no] ip verify source [port-security]

```

port-security	IP Source Guard	IP+MAC
----------------------	-----------------	--------

```

IP Source Guard      IP
IP+MAC
IP Source Guard      DHCP Snooping      Trust
DHCP Snooping      IP Source Guard      IP Source Guard

```

```

1 IP Source Guard
Ruijie# configure terminal
Ruijie(config)# interface fastEthernet 0/1
Ruijie(config-if)# ip verify source
Ruijie(config-if)# end

```

-	-

38.3 IP Source Guard

38.3.1 show ip source binding

IP

show ip source binding [*ip-address*] [*mac-address*] [**dhcp-snooping**] [**static**] [**vlan** *vlan-id*] [**interface** *interface-id*]

<i>ip-address</i>	ip
<i>mac-address</i>	mac
dhcp-snooping	
static	
<i>vlan-id</i>	vlan

|

|

-	-

|

|

-	-

cpu-protect sub-interface {manage|protocol|route} percent percent_vaule

<i>percent_vaule</i>	1	100

(Manage) 30
 (Route) 25
 (Protocol) 45

|

|

Ruijie(config)# **cpu-protect sub-interface manage percent 60**

cpu-protect sub-interface { manage protocol / route } pps	

|

-	-

39.3 ARP

39.3.1 arp-guard attack-threshold

arp-guard attack-threshold {per-src-ip | per-src-mac | per-port} *pps*

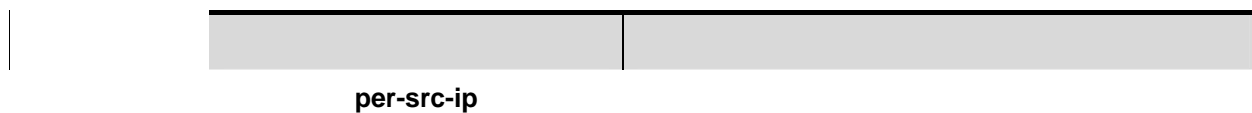

39.3.2 arp-guard enable

ARP

arp-guard enable

	-	-

|

ARP

|

NFPP

|

|

```
Ruijie(config)# nfpp
Ruijie(config-nfpp)# arp-guard enable
```

|

nfpp arp-guard enable	ARP
show nfpp arp-guard summary	

|

|

--	--

NFPP

```
Ruijie(config)# nfpp
Ruijie(config-nfpp)# arp-guard isolate-period 180
```

nfpp arp-guard isolate-period	
show nfpp arp-guard summary	

-	-

39.3.4 arp-guard monitor-period

arp-guard monitor-period *seconds*

<i>seconds</i>	[180, 86400]

600

NFPP

0

0

```
Ruijie(config)# nfpp
```

```
Ruijie(config-nfpp)# arp-guard monitor-period 180
```

show nfpp arp-guard summary

-	-

39.3.7 arp-guard scan-threshold

arp-guard scan-threshold *pkt-cnt*

<i>pkt-cnt</i>	[1,9999]

15	10
----	----

NFPP

10	15	ARP	MAC	IP
	MAC	IP	IP	

```
Ruijie(config)# nfpp
Ruijie(config-nfpp)# arp-guard scan-threshold 20
```

nfpp arp-guard scan-threshold	
show nfpp arp-guard summary	

clear nfpp arp-guard hosts [vlan vid] [interface interface-id] [ip-address | mac-address]

<i>vid</i>	
<i>interface-id</i>	
<i>ip-address</i>	IP
<i>mac-address</i>	MAC

└───┘

└───┘

└───┘

└───┘

VLAN 1 g 0/1
Ruijie# **clear nfpp arp-guard hosts vlan 1 interface g0/1**

arp-guard attack-threshold	
nfpp arp-guard policy	
show nfpp arp-guard hosts	

└───┘

-	-

39.3.9 clear nfpp arp-guard scan

ARP

clear nfpp arp-guard scan

-	-

└───┘

|

|

|

Ruijie# **clear nfpp arp-guard scan**

|

arp-guard scan-threshold	
nfpp arp-guard scan-threshold	
show nfpp arp-guard scan	ARP

|

|

-	-

39.3.10 nfpp arp-guard enable

ARP

nfpp arp-guard enable

|

-	-

|

ARP

|

|

ARP

ARP

|

Ruijie(config)# **interface G0/1**
 Ruijie(config-if)# **nfpp arp-guard enable**

|

arp-guard enable	ARP
show nfpp arp-guard summary	

10.4	

39.3.11 nfpp arp-guard isolate-period

nfpp arp-guard isolate-period {*seconds* | **permanent**}

<i>seconds</i>	0 [30, 86400]
permanent	

nfpp arp-guard policy {per-src-ip | per-src-mac | per-port} *rate-limit-pps*
attack-threshold-pps

per-src-ip	IP
per-src-mac	MAC
per-port	
<i>rate-limit-pps</i>	1 9999
<i>attack-threshold-pps</i>	1 9999

```
Ruijie(config)# interface G 0/1
Ruijie(config-if)# nfpp arp-guard policy per-src-ip 2 10
Ruijie(config-if)# nfpp arp-guard policy per-src-mac 3 10
Ruijie(config-if)# nfpp arp-guard policy per-port 50 100
```

arp-guard attack-threshold	
arp-guard rate-limit	
show nfpp arp-guard summary	
show nfpp arp-guard hosts	
clear nfpp arp-guard hosts	

10.4	
------	--

39.3.13 nfpp arp-guard scan-threshold

nfpp arp-guard scan-threshold *pkt-cnt*

<i>pkt-cnt</i>	[1,9999]

ARP ARP

```
Ruijie(config)# interface G 0/1
Ruijie(config-if)# nfpp arp-guard scan-threshold 20
```

	<i>pps</i>	[1,9999]
--	------------	----------

	MAC	10	300
--	-----	----	-----

NFPP

```
Ruijie(config)# nfpp
Ruijie(config-nfpp)# dhcp-guard attack-threshold per-src-mac 15
Ruijie(config-nfpp)# dhcp-guard attack-threshold per-port 200
```

	nfpp dhcp-guard policy	
	show nfpp dhcp-guard summary	
	show nfpp dhcp-guard hosts	
	clear nfpp dhcp-guard hosts	

	-	-

39.4.2 dhcp-guard enable

DHCP

dhcp-guard enable

	-	-

DHCP

NFPP

```
Ruijie(config)# nfpp
Ruijie(config-nfpp)# dhcp-guard enable
```

nfpp dhcp-guard enable	DHCP
show nfpp dhcp-guard summary	

-	-

39.4.3 dhcp-guard isolate-period

dhcp-guard isolate-period {seconds | permanent}

<i>seconds</i>	0 [30, 86400]
permanent	

0

NFPP

```
Ruijie(config)# nfpp
Ruijie(config-nfpp)# dhcp-guard isolate timeout 180
```

nfpp dhcp-guard isolate-period	

NFPP

dhcp-guard rate-limit { per-src-mac | per-port} pps

per-src-mac	MAC
per-port	
<i>pps</i>	[1,9999]

	MAC	5	150
--	-----	---	-----

NFPP

```
Ruijie(config)# nfpp
Ruijie(config-nfpp)# dhcp-guard rate-limit per-src-mac 8
Ruijie(config-nfpp)# dhcp-guard rate-limit per-port 100
```

|
|
|

|
|
|

|
|
|

|
|
|

VLAN 1 g 0/1

Ruijie# **clear nfpp dhcp-guard hosts vlan 1 interface g0/1**

|
|
|
|

dhcp-guard attack-threshold	
nfpp dhcp-guard policy	
show nfpp dhcp-guard hosts	

|
|
|

|
|
|

--	--

39.4.10 nfpp dhcp-guard policy

nfpp dhcp-guard policy { per-src-mac | per-port} rate-limit-pps attack-threshold-pps

per-src-mac	MAC
per-port	
<i>rate-limit-pps</i>	1 9999
<i>attack-threshold-pps</i>	1 9999

```
Ruijie(config)# interface G 0/1
Ruijie(config-if)# nfpp dhcp-guard policy per-src-mac 3 10
Ruijie(config-if)# nfpp dhcp-guard policy per-port 50 100
```

dhcp-guard attack-threshold	
dhcp-guard rate-limit	
show nfpp dhcp-guard summary	
show nfpp dhcp-guard hosts	
clear nfpp dhcp-guard hosts	

10.4	
------	--

39.5 DHCPv6

39.5.1 dhcpv6-guard attack-threshold

dhcpv6-guard attack-threshold { per-src-mac | per-port} pps

per-src-mac	MAC	
per-port		
<i>pps</i>		[1,9999]

MAC	10	300
-----	----	-----

NFPP

```
Ruijie(config)# nfpp
Ruijie(config-nfpp)# dhcpv6-guard attack-threshold per-src-mac 15
Ruijie(config-nfpp)# dhcpv6-guard attack-threshold per-port 200
```

nfpp dhcpv6-guard policy	
show nfpp dhcpv6-guard summary	
show nfpp dhcpv6-guard hosts	
clear nfpp dhcpv6-guard hosts	

10.4	

39.5.2 dhcpv6-guard enable

DHCPv6

dhcpv6-guard enable

	-	-

DHCPv6

NFPP

```
Ruijie(config)# nfpp
Ruijie(config-nfpp)# dhcpv6-guard enable
```

nfpp dhcpv6-guard enable		DHCPv6
show nfpp dhcpv6-guard summary		

	10.4	

39.5.3 dhcpv6-guard isolate-period

dhcpv6-guard isolate-period {seconds | permanent}

<i>seconds</i>	0	[30, 86400]
permanent		

0

NFPP



show nfpp dhcpv6-guard summary	
show nfpp dhcpv6-guard hosts	
clear nfpp dhcpv6-guard hosts	

└───┘

10.4	

39.5.5 dhcpv6-guard monitored-host-limit

dhcpv6-guard monitored-host-limit *number*

<i>number</i>	1
	4294967295

└───┘

1000

└───┘

NFPP

└───┘

1000 " %ERROR The value that you configured is smaller than current monitored hosts 1000 please clear a part of monitored hosts."

└───┘

" % NFPP_DHCP_GUARD-4-SESSION_LIMIT: Attempt to exceed limit of 1000 monitored hosts."

└───┘

Ruijie(config)# **nfpp**
 Ruijie(config-nfpp)# **dhcp-guard monitored-host-limit 200**

show nfpp dhcpv6-guard summary	

	10.4	

39.5.6 dhcpv6-guard rate-limit

dhcpv6-guard rate-limit { per-src-mac | per-port} pps

	per-src-mac	MAC
	per-port	
	<i>pps</i>	[1,9999]
	MAC	5
		150

clear nfpp dhcpv6-guard hosts [*vlan vid*] [**interface** *interface-id*] [*mac-address*]

<i>vid</i>	
<i>interface-id</i>	
<i>mac-address</i>	MAC

└───┘

└───┘

└───┘

└───┘

VLAN 1 g 0/1

Ruijie# **clear nfpp dhcpv6-guard hosts vlan 1 interface g0/1**

dhcpv6-guard attack-threshold	
nfpp dhcpv6-guard policy	
show nfpp dhcpv6-guard hosts	

└───┘

10.4	

39.5.8 nfpp dhcpv6-guard enable

DHCPv6

nfpp dhcpv6-guard enable

-	-

└───┘

DHCPv6

|

|

DHCPv6

DHCP

|

```
Ruijie(config)# interface G0/1
Ruijie(config-if)# nfpp dhcpv6-guard enable
```

|

dhcpv6-guard enable	DHCPv6
show nfpp dhcpv6-guard summary	

|

|

10.4	

39.5.9 nfpp dhcpv6-guard isolate-period

nfpp dhcpv6-guard isolate-period {*seconds* | permanent}

|

<i>seconds</i>	0 [30, 86400]
permanent	

|

|

|

|

```
Ruijie(config)# interface G 0/1
Ruijie(config-if)# nfpp dhcpv6-guard isolate-period 180
```

|

--	--

┌

┌

10.4	

39.6 ICMP

39.6.1 icmp-guard attack-threshold

icmp-guard attack-threshold { per-src-ip | per-port} pps

┌

per-src-ip	IP
per-port	
<i>pps</i>	[1,9999]

┌

IP 1200 1500

┌

NFPP

┌

┌

```
Ruijie(config)# nfpp
Ruijie(config-nfpp)# icmp-guard attack-threshold per-src-ip 600
Ruijie(config-nfpp)# icmp-guard attack-threshold per-port 1200
```

┌

nfpp icmp-guard policy	
show nfpp icmp-guard summary	
show nfpp icmp-guard hosts	
clear nfpp icmp-guard hosts	

┌

	-	-

39.6.2 icmp-guard enable

ICMP

icmp-guard enable

--	--	--

<i>seconds</i>	0	[30, 86400]
permanent	0	

0

NFPP

```
Ruijie(config)# nfpp
Ruijie(config-nfpp)# icmp-guard isolate-period 180
```

nfpp icmp-guard isolate-period	
---------------------------------------	--

exceed limit of 1000 monitored hosts."

```
Ruijie(config)# nfpp
Ruijie(config-nfpp)# icmp-guard monitored-host-limit 200
```

show nfpp icmp-guard summary	

-	-

39.6.6 icmp-guard rate-limit

icmp-guard rate-limit { per-src-ip | per-port} pps

per-src-ip	IP
per-port	
<i>pps</i>	[1,9999]

IP 900 1000

NFPP

```
Ruijie(config)# nfpp
Ruijie(config-nfpp)# icmp-guard rate-limit per-src-ip 500
Ruijie(config-nfpp)# icmp-guard rate-limit per-port 800
```

nfpp icmp-guard policy	
show nfpp icmp-guard summary	

|

ICMP

|

|

ICMP

ICMP

|
Ruijie(config)# **interface G0/1**
Ruijie(config-if)# **nfpp icmp-guard enable**

icmp-guard enable	ICMP
show nfpp icmp-guard summary	

|

|
10.4

10.4	

39.6.10 nfpp icmp-guard isolate-period

nfpp icmp-guard isolate-period {seconds | permanent}

|
|
|

<i>seconds</i>	0 [30, 86400]
permanent	

|

|

|

|
Ruijie(config)# **interface G 0/1**
Ruijie(config-if)# **nfpp icmp-guard isolate-period 180**



icmp-guard isolate-period

	clear nfpp icmp-guard hosts	
	10.4	

39.7 ND

39.7.1 nd-guard attack-threshold

nd-guard attack-threshold per-port {ns-na | rs | ra-redirect} pps

	ns-na	
	rs	
	ra-redirect	
	<i>pps</i>	[1,9999]

```

30          /          30
          /          30
    
```

NFPP

```

Ruijie(config)# nfpp
Ruijie(config-nfpp)# nd-guard attack-threshold per-port ns-na 20
Ruijie(config-nfpp)# nd-guard attack-threshold per-port rs 10
Ruijie(config-nfpp)# nd-guard attack-threshold per-port ra-redir
ect 10
    
```

--	--	--

nfpp nd- nd-403 Tw.d-guard attack-tu9nicardyTc 4.8448.695 0 Td()T9.9071 Tf0.0047 T0.006 Td[<4.5pp

┌

10.4	

39.7.2 nd-guard enable

ND

nd-guard enable

-	-

┌

ND

┌

NFPP

┌

```
Ruijie(config)# nfp
Ruijie(config-nfp)# nd-guard enable
```

nfp nd-guard enable	ND
show nfp nd-guard summary	

┌

10.4	

39.7.3 nd-guard rate-limit

nd-guard rate-limit per-port {ns-na | rs | ra-redirect} pps

┌

┌ ND

Ruijie(config)# **interface G0/1**
 Ruijie(config-if)# **nfpp nd-guard enable**

nd-guard enable	ND
show nfpp nd-guard summary	

┌

┌ 10.4

10.4	

39.7.5 nfpp nd-guard policy

**nfpp nd-guard policy per-port {ns-na | rs | ra-redirect} rate-limit-pps attack-thresh
 old-pps**

┌

┌

┌

┌

ns-na	
rs	
ra-redirect	
<i>rate-limit-pps</i>	1 9999
<i>attack-threshold-pps</i>	1 9999

ND snooping

ND snooping

ND snooping

ND guard

800

900

ND guard

ND snooping

ND snooping

```
Ruijie(config)# interface G 0/1
```

```
Ruijie(config-if)# nfpp nd-guard policy per-port ns-na 50 100
```

```
Ruijie(config-if)# nfpp nd-guard policy per-port rs 10 20
```

```
Ruijie(config-if)# nfpp nd-guard policy per-port ra-redirect 10 20
```



```
Ruijie# clear nfpp log
32 log-buffer entries were cleared.
```

show nfpp log	NFPP

10.4	

39.8.2 log-buffer entries

NFPP

log-buffer entries *number*

<i>number</i>	[0,1024]

256

NFPP

```
NFPP 50
Ruijie(config)# nfpp
Ruijie(config-nfpp)# log-buffer entries 50
```

log-buffer logs number_of_message interval length_in_seconds	NFPP
show nfpp log	NFPP

┌

10.4	

39.8.3 log-buffer logs

NFPP

log-buffer logs *number_of_message interval length_in_seconds*

<i>number_of_message</i>	0-1024 0
<i>length_in_seconds</i>	0-86400 1 0
	<i>number_of_message</i> <i>length_in_seconds</i> 0 <i>number_of_message</i> / <i>length_in_second</i>

┌

number_of_message 1 *length_in_seconds* 30

┌

NFPP

┌

```
Ruijie(config)# nfpp
Ruijie(config-nfpp)# log-buffer logs 2 interval 12
```

┌

log-buffer entries <i>number</i>	NFPP
show nfpp log summary	NFPP

┌



10.4	

39.8.4 logging

NFPP VLAN

logging vlan *vlan-range*

logging interface *interface-id*

<i>vlan-range</i>	VLAN " 1-3,5"
<i>interface-id</i>	

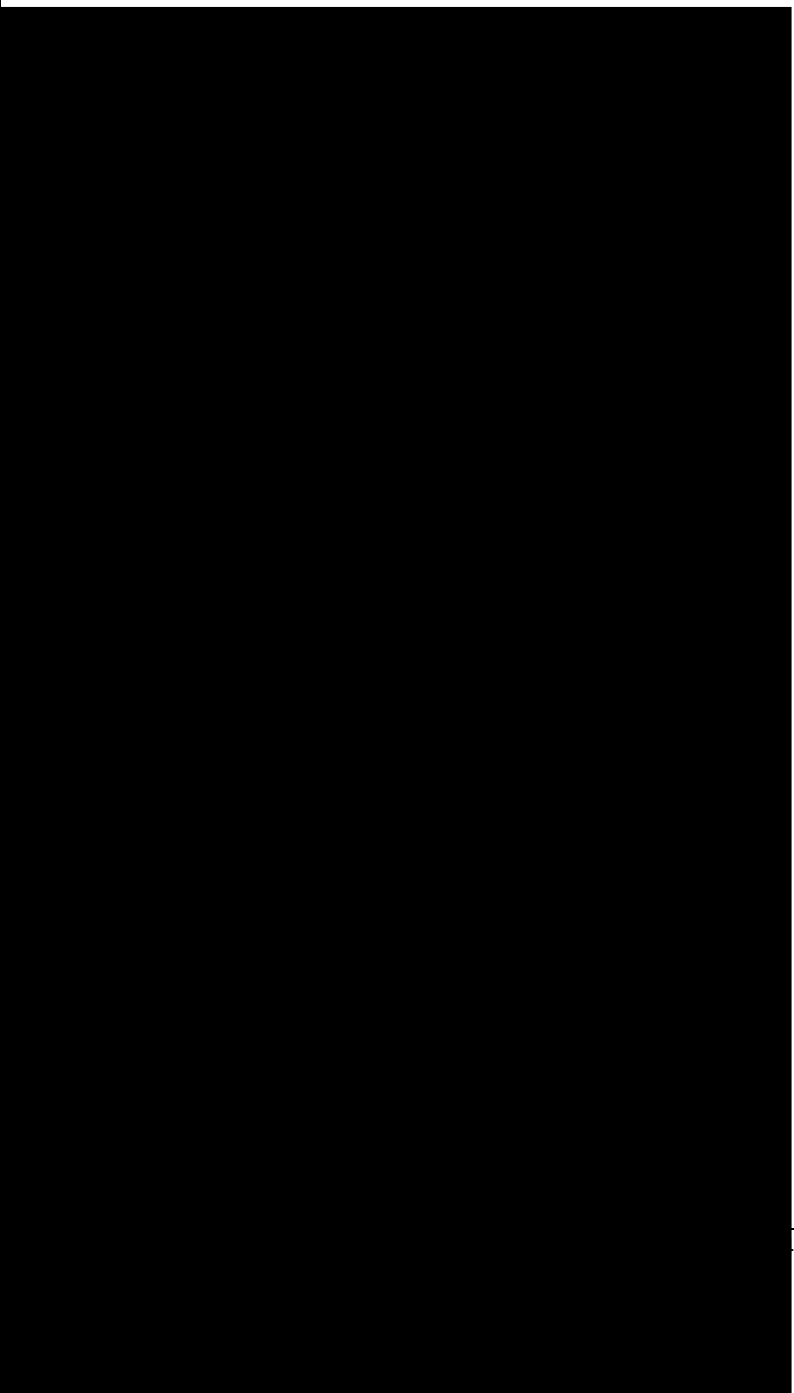

39.8.5 show nfpp log

NFPP

show nfpp log summary

NFPP

show nfpp log buffer [statistics]

statistics	NFPP

"_"

%NFPP_ARP_GUARD-4-DOS_DETECTED: Host<IP=N/A,MAC=0000.0000.0004,port=Gi4/1,VLAN=1> was detected.(2009-07-01 13:00:00)

NFPP

Ruijie#**show nfpp log summary**

Total log buffer size : 10

Syslog rate : 1 entry per 2 seconds

Logging:

VLAN 1-3, 5

interface Gi 0/1

interface Gi 0/2

NFPP

Ruijie#**show nfpp log buffer statistics**

There are 6 logs in buffer.

NFPP

Ruijie#**show nfpp log buffer**

Protocol VLAN Interface IP address MAC address Reason

Timestamp

10.4

39.9 ARP

39.9.1 show nfpp arp-guard hosts

show nfpp arp-guard hosts [**statistics** | [[*vlan vid*] [**interface** *interface-id*] [*ip-address* | *mac-address*]]]

statistics	
<i>vid</i>	
<i>interface-id</i>	
<i>ip-address</i>	IP
<i>mac-address</i>	MAC

```

1
Ruijie# show nfpp arp-guard hosts statistics
success  fail  total
-----  ----  -----
100      20    120
          120          100          20

```

```

2          " remain-time(seconds)"
Ruijie# show nfpp arp-guard hosts
If column 1 shows '*', it means "hardware do not isolate user" .
VLAN  interface IP address  MAC address  remain-time(s)
----  -
1     Gi0/1    1.1.1.1     -            110
2     Gi0/2    1.1.2.1     -            61
*3    Gi0/3    -           0000.0000.1111 110

```

```

4      Gi0/4      -      0000.0000.2222  61
Total  4 hosts

```

clear nfpp arp-guard hosts	

-	-

39.9.2 show nfpp arp-guard scan

ARP

show nfpp arp-guard scan [**statistics** | [[**vlan** *vid*] [**interface** *interface-id*] [*ip-address*] [*mac-address*]]]

statistics	ARP
<i>vid</i>	
<i>interface-id</i>	
<i>ip-address</i>	IP
<i>mac-address</i>	MAC

```
Ruijie# show nfpp arp-guard scan statistics
```

```
ARP scan table has 4 record(s).
```

```
    " ARP          4          "
```

```
Ruijie# show nfpp arp-guard scan
```

```
VLAN   interface  IP address  MAC address  timestamp
```

```

-----
1      Gi0/1      N/A      0000.0000.0001  2008-01-23
16:23:10
2      Gi0/2      1.1.1.1  0000.0000.0002  2008-01-23
16:24:10
3      Gi0/3      N/A      0000.0000.0003  2008-01-23
16:25:10
4      Gi0/4      N/A      0000.0000.0004  2008-01-23
16:26:10
Total  4 record(s)

" timestamp"          ARP          " 2008-01-23 16:23:10"
  2008  1  23  16  23  10          ARP
    
```

```

Ruijie# show nfpp arp-guard scan vlan 1 interface G 0/1
0000.0000.0001
VLAN   interface  IP address  MAC address  timestamp
-----
1      Gi0/1      N/A        0000.0000.0001  2008-01-23
16:23:10
Total  1 record(s)
    
```

arp-guard scan-threshold	
nfpp arp-guard scan-threshold	
clear nfpp arp-guard scan	ARP

-	-

39.9.3 show nfpp arp-guard summary

show nfpp arp-guard summary

-	-

```
Ruijie# show nfpp arp-guard summary
```

```
Format of column Rate-limit and Attack-threshold is per-src-ip
/per-src-mac/per-port.
```

Interface	Status	Isolate-period	Rate-limit	Attack-threshold	Scan-threshold
Global	Enable	300	4/5/60	8/10/100	15
Gi 0/1	Enable	180	5/-/-	8/-/-	-
Gi 0/2	Disable	200	4/5/60	8/10/100	20

```
Maximum count of monitored hosts: 1000
```

```
Monitor period 300s
```

1	Interface	Global			
2	Status				
3	Rate-limit		IP	/	MAC
	/		Attack-threshold		" -"

arp-guard attack-threshold	
arp-guard enable	ARP
arp-guard isolate-period	
arp-guard monitor-period	
arp-guard monitored-host-limit	
arp-guard rate-limit	
arp-guard scan-threshold	
nfpp arp-guard enable	ARP
nfpp arp-guard isolate-period	

┌

┌

-	-

39.10 DHCP

39.10.1 show nfpp dhcp-guard hosts

show nfpp dhcp-guard hosts [**statistics** | [[**vlan** *vid*] [**interface** *interface-id*] [*mac-address*]]]

┌

statistics	
<i>vid</i>	
<i>interface-id</i>	
<i>mac-address</i>	MAC

┌

┌

┌

┌

Ruijie# **show nfpp dhcp-guard hosts statistics**

```

success   fail   total
-----   ----   -----
100         20     120
           120         100         20
    
```

" remain-time(seconds)"

Ruijie# **show nfpp dhcp-guard hosts**

If column 1 shows '*', it means "hardware failed to isolate host".

```

VLAN   interface   MAC address   remain-time(seconds)
    
```

----	-----	-----	-----
1	gi0/2	0000.0000.0001	10
*2	gi0/1	0000.0000.0002	20
Total	2 host(s)		

clear nfpp dhcp-guard hosts	

┌

10.4	

39.10.2 show nfpp dhcp-guard summary

show nfpp dhcp-guard summary

-	-

┌

┌

┌

Ruijie# **show nfpp dhcp-guard summary**

Format of column Rate-limit and Attack-threshold is per-src-ip /per-src-mac/per-port.

```

1      Interface  Global
2      Status
3      Rate-limit          IP          /      MAC
/          Attack-threshold          "  _"
    
```

dhcp-guard attack-threshold	
dhcp-guard enable	DHCP
dhcp-guard isolate-period	
dhcp-guard monitor-period	
dhcp-guard monitored-host-limit	
dhcp-guard rate-limit	
nfpp dhcp-guard enable	DHCP
nfpp dhcp-guard isolate-period	
nfpp dhcp-guard policy	

10.4	

39.11 DHCPv6

39.11.1 show nfpp dhcpv6-guard hosts

show nfpp dhcpv6-guard hosts [**statistics** | [[**vlan** *vid*] [**interface** *interface-id*] [**mac** *-address*]]]

statistics	
<i>vid</i>	
<i>interface-id</i>	

<i>mac-address</i>	MAC
--------------------	-----

Ruijie# **show nfpp dhcpv6-guard hosts statistics**

```

success    fail    total
-----    -
100         20     120
          120         100     20
  
```

" remain-time(seconds)"

Ruijie# **show nfpp dhcpv6-guard hosts**

If column 1 shows '*', it means "hardware failed to isolate host".

```

VLAN  interface  MAC address  remain-time(seconds)
----  -
1     gi0/2       0000.0000.0001  10
*2    gi0/1       0000.0000.0002  20
Total 2 host(s)
  
```

-	-

Ruijie# **show nfpp dhcpv6-guard summary**

Format of column Rate-limit and Attack-threshold is per-src-ip /per-src-mac/per-port.

Interface	Status	Isolate-period	Rate-limit	Attack-threshold
Global	Enable	300	-/5/150	-/10/300
Gi 0/1	Enable	180	-/6/-	-/8/-
Gi 0/2	Disable	200	-/5/30	-/10/50

Maximum count of monitored hosts: 1000

Monitor period 300s

- 1 Interface Global
- 2 Status
- 3 Rate-limit IP / MAC
- / Attack-threshold " -"

|

|

10.4	

39.12 ICMP

39.12.1 show nfpp icmp-guard hosts

show nfpp icmp-guard hosts [**statistics** | [[**vlan** *vid*] [**interface** *interface-id*] [*ip-address*]]]

|

statistics	
<i>vid</i>	
<i>interface-id</i>	
<i>ip-address</i>	

2 Gi0/2 1.1.2.1 61
Total 2 host(s)

clear nfpp icmp-guard hosts	

10.4	

ow nfpp icmp-guard summary

fpf icmp-guard summary

```

2      Status
3      Rate-limit          IP          /      MAC          /
                          Attack-threshold      " _"
    
```

icmp-guard attack-threshold	
icmp-guard enable	ICMP
icmp-guard isolate-period	
icmp-guard monitor-period	
icmp-guard monitored-host-limit	
icmp-guard rate-limit	
nfpp icmp-guard enable	ICMP
nfpp icmp-guard isolate-period	
nfpp icmp-guard policy	

10.4	

39.12.3 show nfpp icmp-guard trusted-host

show nfpp icmp-guard trusted-host

-	-

```
Ruijie# show nfpp icmp-guard trusted-host
IP address      mask
-----
1.1.1.0         255.255.255.0
```

```

Gi 0/1      Enable 15/15/15 30/30/30
Gi 0/2      Disable -/5/30  -/10/50
    
```

```

1      Interface  Global
2      Status
3      Rate-limit          /          /
      /          /          Attack-threshold
      " -"
      " -/5/30"          G 0/2          /
          5          /          30
    
```

nd-guard attack-threshold	
nd-guard enable	ND
nd-guard rate-limit	
nfpp nd-guard enable	ND
nfpp nd-guard policy	

--	--

40 ACL

id	IP ACL 1-99 1300-1999 IP ACL 100-199 2000-2699 MAC ACL 700-799 ACL 2700-2899
name	ACL
sn	ACL ()
start-sn	
inc-sn	
deny	
permit	
prot	IPv6 ipv6 icmp tcp udp 0-255 IPv4 eigrp gre ipinip igmp nos ospf icmp udp

precedence precedence	0-7
range	
time-range tm-rng-name	tm-rng-name
tos tos	0-15
cos cos	cos (0-7)
cos inner cos	tag cos
icmp-type	ICMP 0-255
icmp-code	ICMP 0-255
icmp-message	ICMP
operator port[port]	Operator lt- eq- gt- neq- range- port

B	MAC	6	P		35
C		12	Q	IP	36
D	VLAN tag	14	R	ip	38
E	DSAP()	18	S	ip	42
F	SSAP()	19	T	TCP	46
G	Ctrl	20	U	TCP	48
H	Org Code	21	V		50
I					

4) Expert 2700 - 2899

access-list *id* {deny | permit} [protocol | [ethernet-type][cos [out][inner in]]] [VID [out][inner in]] {source source-wildcard | host source | any} {host source-mac-address | any} {destination destination-wildcard | host destination | any} {host destination-mac-address | any} [[precedence precedence] [tos tos] [fragments] [range lower upper] [time-range time-range-name]

Ethernet-type cos

access-list *id* {deny | permit} {ethernet-type| cos [out][inner in]] [VID [out][inner in]] {source source-wildcard | host source | any} {host source-mac-address | any } {destination destination-wildcard | host destination | any} {host destination-mac-address | any} [time-range time-range-name]

Protocol

access-list *id* {deny | permit} protocol [VID [out][inner in]] {source source-wildcard | host source | any} {host source-mac-address | any } {destination destination-wildcard | host destination | any} {host destination-mac-address | any} [precedence precedence] [tos tos] [fragments] [range lower upper] [time-range time-range-name]

Expert

Internet Control Message Protocol (ICMP)

access-list *id* {deny | permit} icmp [VID [out][inner in]] {source source-wildcard | host source | any} {host source-mac-address | any } {destination destination-wildcard | host destination | any} {host destination-mac-address | any} [icmp-type] [[icmp-type [icmp-code]] | [icmp-message]] [precedence precedence] [tos tos] [fragments] [time-range time-range-name]

Transmission Control Protocol (TCP)

access-list *id* {deny | permit} tcp [VID [out][inner in]] {source source-wildcard | host Source | any} {host source-mac-address | any } [operator port [port]] {destination destination-wildcard | host destination | any} {host destination-mac-address | any} [operator port [port]] [precedence precedence] [tos tos] [fragments] [range lower upper] [time-range time-range-name] [match-all tcp-flag]

User Datagram Protocol (UDP)

access-list *id* {deny | permit} udp[VID [out][inner in]] {source source -wildcard | host source | any} {host source-mac-address | any } [operator port [port]] {destination destination-wildcard | host destination | any}{host destination-mac-address | any} [operator port [port]] [precedence precedence] [tos tos] [fragments] [range lower upper] [time-range time-range-name]

5)

access-list *list-remark text*

<i>id</i>	1-99 100-199 1300-1999 2000-2699 2700 – 2899 700 - 799
Deny	
Permit	
<i>Source</i>	
<i>source-wildcard</i>	0.255.0.32
<i>protocol</i>	IP EIGRP GRE IPINIP IGMP NOS OSPF ICMP UDP TCP IP IP 0-255 ICMP/TCP/UDP
<i>Destination</i>	
<i>destination-wildcard</i>	0.255.0.32
fragments	
precedence	
<i>precedence</i>	0-7
range	
<i>lower</i>	
<i>upper</i>	
time-range	
<i>time-range-name</i>	
tos	
<i>tos</i>	0-15
<i>icmp-type</i>	ICMP 0-255
<i>icmp-code</i>	ICMP 0-255
<i>icmp-message</i>	ICMP
<i>operator</i>	lt- eq- gt- neq- range-
port [<i>port</i>]	<i>range</i>
host <i>source-mac-address</i>	
host <i>destination-mac-address</i>	
VID <i>vid</i>	<i>vid</i>
<i>ethernet-type</i>	

match-all	<i>tcp flag</i>
<i>tcp-flag</i>	tcp flag

ACL

access-list

dod-host-prohibited
dod-net-prohibited
echo
echo-reply
fragment-time-exceeded
general-parameter-problem
host-isolated
host-precedence-unreachable
host-redirect
host-tos-redirect
host-tos-unreachable
host-unknown
host-unreachable
information-reply
information-request
mask-reply
mask-request
mobile-redirect
net-redirect
net-tos-redirect
net-tos-unreachable
net-unreachable
network-unknown
no-room-for-option
option-missing
packet-too-big
parameter-problem
port-unreachable
precedence-unreachable
protocol-unreachable
redirect
router-advertisement
router-solicitation
source-quench
source-route-failed
time-exceeded
timestamp-reply
timestamp-request

ttl-exceeded		
unreachable		
TCP		TCP
bgp		
chargen		
cmd		
daytime		
discard		
domain		
echo		
exec		
finger		
ftp		
ftp-data		
gopher		
hostname		
ident		
irc		
klogin		
kshell		
login		
nntp		
pim-auto-rp		
pop2		
pop3		
smtp		
sunrpc		
syslog		
tacacs		
talk		
telnet		
time		
uucp		
whois		
www		
UDP		UDP
biff		
bootpc		

bootps
discard
dnsix
domain
echo
isakmp
mobile-ip
nameserver
netbios-dgm
netbios-ns
netbios-ss
ntp
pim-auto-rp
rip
snmp
snmptrap
sunrpc
syslog
tacacs
talk
tftp
time
who
xdmcp

Ethernet-type

aarp
arp
appletalk
decnet-iv
diagnostic
etype-6000
etype-8042
lat
lavc-sca
mop-console
mop-dump
mumps
netbios

vines-echo
xns-idp

```
1 IP
   IP                192.168.1.64 - 192.168.1.127
```

```
Ruijie(config)# access-list 1 permit 192.168.1.64 0.0.0.63
```

```
2 IP
   IP                DNS      ICMP
```

```
Ruijie(config)# access-list 102 permit tcp any any eq domain
```

```
Ruijie(config)# access-list 102 permit udp any any eq domain
```

```
Ruijie(config)# access-list 102 permit icmp any any echo
```

```
Ruijie(config)# access-list 102 permit icmp any any echo-reply
```

```
3 MAC
   MAC 00d0f8000c0c          100
access-list
```

40.1.2 deny

(deny)

1 IP

[sn] deny {source source-wildcard 1

[sn] d{ } [(s)-8((s)8(d)(e)17-5000) T 30000 AdP) (s)VF28(1)F408_37486)T134(56)E246

destination-wildcard | **host** *destination* | **any** {**host** *destination-mac-address* | **any**}
[time-range *time-range-name*]

b) protocol

[*sn*] **deny protocol** [[**VID** [*out*][*inner in*]]] {*source source-wildcard* | **host source** | **any**}
 {**host source-mac-address** | **any**} {*destination destination-wildcard* | **host destination** | **any**}
 {**host destination-mac-address** | **any**} [**precedence precedence**] [**tos tos**] [**fragments**]
[range *lower upper*] [~~**time-range**~~ *name*]

c) expert

Internet Control Message Protocol (ICMP)

[*sn*] **deny icmp** [[**VID** [*out*][*inner in*]]] {*source source-wildcard* | **host source** | **any**} {**host**
source-mac-address | **any**} {*destination destination-wildcard* | **host destination** | **any**} {**host**
destination-mac-address | **any**} [*icmp-type*] [[*icmp-type icmp-code*]] | [*icmp-message*]]
[precedence precedence] [tos tos] [frag-6()]931 Tf0(upper)c 0 Tw 2.571 0 Td[(icmp)-65 Tf2BE3C02D6>T/TT0 1 Tf

[[*icmp-type* [*icmp-code*]] | [*icmp-message*]] [**dscp** *dscp*] [**flow-label** *flow-label*] [**fragments**] [**time-range** *time-range-name*]

Transmission Control Protocol (TCP)

[*sn*] **deny tcp** {*source-ipv6-prefix* / *prefix-length* | **host** *source-ipv6-address* | **any**}[*operator* **port**[*port*]] {*destination-ipv6-prefix* /*prefix-length* | **host** *destination-ipv6-address* | **any**} [*operator* **port** [*port*]] [**dscp** *dscp*] [**flow-label** *flow-label*] [**fragments**] [**range** *lower upper*] [**time-range** *time-range-name*] [**match-all** *tcp-flag*]

User Datagram Protocol (UDP)

[*sn*] **deny udp** {*source-ipv6-prefix/prefix-length* | **host** *source-ipv6-address* | **any**} [*operator* **port** [*port*]] {*destination-ipv6-prefix* /*prefix-length* | **host** *destination-ipv6-address* | **any**}[*operator* **port** [*port*]] [**dscp** *dscp*] [**flow-label** *flow-label*] [**fragments**] [**range** *lower upper*] [**time-range** *time-range-name*]

<i>Sn</i>	ACL
<i>source-ipv6-prefix</i>	IPv6
<i>destination-ipv6-prefix</i>	IPv6
<i>prefix-length</i>	
<i>source-ipv6-address</i>	IPv6
<i>destination-ipv6-address</i>	IPv6
dscp	
<i>dscp</i>	0-63.
flow-label	
<i>flow-label</i>	0-1048575
<i>protocol</i>	IPV6 <0-255> IPV6 icmp tcp udp

```
192.168.4.12 host 0013.0049.8272 any any
Ruijie(config-exp-nacl)# permit any any any any
Ruijie(config-exp-nacl)# show access-lists
expert access-list extended 2702
10 deny tcp host 192.168.4.12 host 0013.0049.8272 any any
20 permit any any any any
Ruijie(config-exp-nacl)#
2 192.168.4.12 host 0013.0049.8272 x p - n a c l #
```

1

```
Ruijie(config)# ipv6 access-list extended v6-acl
Ruijie(config-ipv6-nacl)# 11 deny ipv6 host 192.168.4.12 any
Ruijie(config-ipv6-nacl)# show access-lists
ipv6 access-list extended v6-acl
11 deny ipv6 host 192.168.4.12 any
Ruijie(config-ipv6-nacl)# exit
Ruijie(config)# interface gigabitethernet 1/1
Ruijie(config-if)# ipv6 traffic-filter v6-acl in
```

show access-lists	
ipv6 traffic-filter	IPV6
ip access-group	IP ACL
mac access-group	MAC ACL
ip access-list	IP ACL
mac access-list	MAC ACL
expert access-list	ACL
ipv6 access-list	IPV6 ACL
permit	

V10.0	V10.0 arp V10.2(3)
-------	-----------------------

40.1.3 expert access-group

EXPERT ACL

no

expert access-group {id | name} {in | out}

no expert access-group {id | name} {in | out}

<i>id</i>	Expert	7	\$	5
-----------	--------	---	----	---

in	
out	

Expert ACL

ACL **show**
access-group

```
access-list accept_00d0f8xxxxx_only Gigabit 1
Ruijie(config)# interface GigaEthernet 0/1
Ruijie(config-if)# expert access-group accept_00d0f8xxxxx_only in
```



show expert access-lists

```

1          ACL
Ruijie(config)# expert access-list extended exp-acl
Ruijie(config-exp-nacl)# show expert access-lists
expert access-list extended exp-acl
Ruijie(config-exp-nacl)#

2          ACL
Ruijie(config)# expert access-list extended 2704
Ruijie(config-exp-nacl)# show expert access-lists
expert access-list extended 2704
Ruijie(config-exp-nacl)#
    
```

show expert access-lists	

V10.0	V10.0

40.1.5 ip access-group

ip access-group no

ip access-group {*id* | *name*} {**in** | **out**}

no ip access-group { *id* | *name*} {**in** | **out**}

<i>id</i>	IP 1-199 1300-2699
<i>name</i>	IP
in	
out	

ACL

-199 1300

1 ACL

```
Ruijie(config)# ip access-list standard std-acl
```

```
Ruijie(config-std-nacl)# show ip access-lists
```

```
ip access-list standard std-acl
```

```
Ruijie(config-std-nacl)#
```

2 ACL

```
Ruijie(config)# ip access-list extended 123
```

```
Ruijie(config-ext-nacl)# show ip access-lists
```

```
ip access-list extended 123
```



show access-lists

ACL

Ruijie# **show access-lists**

ip access-list standard 1

10 permit host 192.168.4.12

20 deny any any

Ruijie# **config**

Ruijie(config)# **ip access-list resequence 1 21 43**

Ruijie(config)# **exit**

Ruijie# **show access-lists**

ip access-list standard 1

21 permit host 192.168.4.12

64 deny any any

show access-lists	

V10.0	V10.0

40.1.8 ipv6 traffic-filter

IPV6 ACL

no

ipv6 traffic-filter *name* {in | out}

no ipv6 traffic-filter *name* {in | out}

<i>name</i>	IPV6
in	
out	

IPV6 ACL

|

|

|

ACL
traffic-filter

show ipv6

```
access-list v6-acl Gigabit 1
Ruijie(config)# interface GigaEthernet 0/1
Ruijie(config-if)# ipv6 traffic-filter v6-acl in
```

show ipv6 access-lists	IPV6
V10.0	V10.0

40.1.10 MAC access-group

MAC ACL

no

mac access-group {*id* | *name*}{**in** | **out**}

no mac access-group {*id* | *name*} {**in** | **out**}

<i>id</i>	MAC 700-799
<i>name</i>	MAC
in	
out	

ACL

show running-config

```

access-list accept_00d0f8xxxxxx_only Gigabit 1
Ruijie(config)# interface GigaEthernet 1/1
Ruijie(config-if)# mac access-group accept_00d0f8xxxxxx_only in
    
```

show access-group	ACL

V10.0	V10.0

40.1.11 MAC access-list

MAC ACL **no** ACL

mac access-list extended {*id* | *name*}

no mac access-list extended {*id* | *name*}

<i>id</i>	MAC 700-799
<i>name</i>	MAC

MAC ACL

show mac access-lists

1 MAC ACL

Ruijie(config)# **mac access-list extended** *mac-acl*

Ruijie(config-mac-nacl)# **show mac access-lists**

mac access-list extended *mac-acl*

2 MAC ACL

Ruijie(config)# **mac access-list extended** *704*

Ruijie(config-mac-nacl)# **show mac access-lists**

mac access-list extended *704*

show mac access-lists	mac

V10.0	V10.0

40.1.13 permit

(permit)

1) IP

[sn] **permit** {*source source-wildcard* | **host** *source* | **any**}

2) IP

[sn] **permit protocol** *source source-wildcard destination destination-wildcard* [**precedence** *precedence*] [**tos** *tos*] [**fragments**] [**range** *lower upper*] [**time-range** *time-range-name*]

IP

Internet Control Message Protocol (ICMP)

[sn] **permit icmp** {*source source-wildcard* | **host** *source* | **any**} {*destination destination-wildcard* | **host** *destination-wildcard* |

Ethernet-type cos

[sn] **permit** {*ethernet-type* | **cos** [*out*] [*inner in*]} [**VID** [*out*][*inner in*]] {*source source-wildcard* | **host source** | **any**} {**host source-mac-address** | **any**} {*destination destination-wildcard* | **host destination** | **any**} {**host destination-mac-address** | **any**} [**time-range** *time-range-name*]

Protocol

[sn] **permit protocol** [**VID** [*out*][*inner in*]] {*source source-wildcard* | **host Source** | **any**} {**host source-mac-address** | **any**} {*destination destination-wildcard* | **host destination** | **any**} {**host destination-mac-address** | **any**} [**precedence precedence**] [**tos tos**] [**fragments**] [**range lower upper**] [**time-range** *time-range-name*]

Expert

Internet Control Message Protocol (ICMP)

[sn] **permit icmp** [**VID** [*out*][*inner in*]] {*source source-wildcard* | **host source** | **any**} {**host source-mac-address** | **any**} {*destination destination-wildcard* | **host destination** | **any**} {**host destination-mac-address** | **any**}[*icmp-type*] [[*icmp-type icmp-code*]] | [*icmp-message*] [**precedence precedence**] [**tos tos**] [**fragments**] [**time-range** *time-range-name*]

Transmission Control Protocol (TCP)

[sn] **permit tcp** [**VID** [*out*][*inner in*]]{*source source-wildcard* | **host Source** | **any**} {**host source-mac-address** | **any**} [*operator port* [*port*]] {*destination destination-wildcard* | **host destination** | **any**} {**host destination-mac-address** | **any**} [*operator port* [*port*]] [**precedence precedence**] [**tos tos**] [**fragments**] [**range lower upper**] [**time-range** *time-range-name*] [**match-all tcp-flag**]

User Datagram Protocol (UDP)

[sn] **permit udp** [**VID** [*out*][*inner in*]]{*source source-wildcard* | **host source** | **any**} {**host source-mac-address** | **any**} [*operator port* [*port*]] {*destination destination-wildcard* | **host destination** | **any**} {**host destination-mac-address** | **any**} [*operator port* [*port*]] [**precedenceprecedence**] [**tos tos**] [**fragments**] [**range lower upper**] [**time-range** *time-range-name*]

Address Resolution Protocol (ARP)

[sn] **permit arp** {*vid vlan-id*} [**host source-mac-address** | **any**] [**host destination-mac-address** | **any**] {*sender-ip sender-ip-wildcard* | **host sender-ip** | **any**} {*sender-mac sender-mac-wildcard* | **host sender-mac** | **any**} {*target-ip target-ip-wildcard* | **host target-ip** | **any**}

5) IPV6

[sn] **permit protocol** {*source-ipv6-prefix / prefix-length* | **any** | **host source-ipv6-address**} {*destination-ipv6-prefix / prefix-length* | **any**} *hostdestination-ipv6-address*} [**dscp dscp**] [**flow-label flow-label**] [**fragments**] [**range lower upper**] [**time-range** *time-range-name*]

IPV6

Internet Control Message Protocol (ICMP)

```
[sn] permit icmp {source-ipv6-prefix / prefix-length | any source-ipv6-address | host}
{destination-ipv6-prefix / prefix-length| host destination-ipv6-address | any} [icmp-type]
[[icmp-type [icmp-code]] | [icmp-message]] [dscp dscp] [flow-label flow-label][fragments]
[time-range time-range-name]
```

Transmission Control Protocol (TCP)

```
[sn] permit tcp {source-ipv6-prefix / prefix-length | host source-ipv6-address | any}
[operator port [port] ] {destination-ipv6-prefix / prefix-length | host destination-ipv6-address
| any} [operator port [port]] [dscp dscp] [flow-label flow-label] [fragments] [range lower
upper] [time-range time-range-name] [match-all tcp-flag]
```

User Datagram Protocol (UDP)

```
[sn] permit udp {source-ipv6-prefix / prefix-length | host source-ipv6-address | any}
[operator port [port] ] {destination-ipv6-prefix / prefix-length | host destination-ipv6-address
| any} [operator port [port]] [dscp dscp] [flow-label flow-label] [fragments] [range lower
upper] [time-range time-range-name]
```

deny	-

ACL

ACL ACL

```

1                                      Expert Extended ACL                      ACL                      IP
192.168.4.12                      MAC                      001300498272                      TCP
Ruijie(config)# expert access-list extended exp-acl
Ruijie(config-exp-nacl)# permit tcp host 192.168.4.12 host
0013.0049.8272 any any
Ruijie(config-exp-nacl)# deny any any any any
Ruijie(config-exp-nacl)# show access-lists
expert access-list extended exp-acl
10 permit tcp host 192.168.4.12 host 0013.0049.8272 any any
20 deny any any any any
Ruijie(config-exp-nacl)#
2                      IP                      ACL                                      IP                      192.168.4.12                                      TCP
```

```
100                                1
Ruijie(config)# ip access-list extended 102
Ruijie(config-ext-nacl)# permit tcp host 192.168.4.12 eq 100 any
Ruijie(config-ext-nacl)# show access-lists
ip access-list extended 102
10 permit tcp host 192.168.4.12 eq 100 any
Ruijie(config-ext-nacl)# exit
Ruijie(config)# interface gigabitethernet 1/1
Ruijie(config-if)# ip access-group 102 in
```

```
Ruijie(config)# interface gigabitethernet 1/1  
Ruijie(config-if)# ipv6 traffic-filter v6-acl in
```



```
show access-lists
```

```
Ruijie# show access-group
ip access-list standard ipstd3
Applied On interface GigabitEthernet 0/1.
ip access-list standard ipstd4
Applied On interface GigabitEthernet 0/2.
ip access-list extended 101
Applied On interface GigabitEthernet 0/3.
ip access-list extended 102
Applied On interface GigabitEthernet 0/8.
```

ip access-group	ip
mac access-group	MAC
expert access-group	Expert
ipv6 traffic-filter	IPV6

V10.0	V10.0

40.2.2 show access-lists

ACL ACL

show access-lists [*id* | *name*]

<i>id</i>	

```

Ruijie# show access-lists n_acl
ip access-list standard n_acl
Ruijie# show access-lists 102
ip access-list extended 102
Ruijie# show access-lists
ip access-list standard n_acl
ip access-list extended 101
mac access-list extended mac-acl
expert access-list extended exp-acl
ipv6 access-list extended v6-acl
    
```

ip access-list	IP ACL
mac access-list	MAC ACL
expert access-list	Expert ACL
ipv6 access-list	IPv6 ACL

V10.0	V10.0

40.2.3 show expert access-group

Expert

ACL

V10.0

V10.0

|

|

MAC ACL

MAC ACL

|

```
Ruijie# show mac access-group interface gigabitethernet 0/3
mac access-group mm in
Applied On interface GigabitEthernet 0/3.
```

|

mac access-list	MAC ACL

|

|

V10.0	V10.0

40.3

40.3.1 security access-group

security access-group {*id*|*name*}

no security access-group

|

<i>id</i>	ACL id
<i>name</i>	ACL

|

|

|

|

```
Ruijie(config-if)#security access-group 1
```

	show secu-acl	

└──

	V10.2	V10.2

40.3.2 security global access-group

security global access-group {*id*|*name*}

no security global access-group

	<i>id</i>	ACL id
	<i>name</i>	ACL

└──

└──

└──

Ruijie(config)#**security global access-group 1**

	show secu-acl	

└──

	V10.2	V10.2

40.3.3 security uplink enable

security uplink enable

no security uplink enable

	-	-

|

|

|

Ruijie(config-if)#**security uplink enable**

	show secu-acl	

|

	V10.2	V10.2

40.3.4 show security

show secu-acl

```
Ruijie(config-if)#show secu-acl
```

```
Ports      Type      access-group
```

```
-----
```

```
Fa0/4      security  50
```

```
Global     security  60
```

```
Fa0/6      uplink    --
```

security global access-group	
security access-group	
security uplink enable	

V10.2	V10.2

41 QOS

41.1

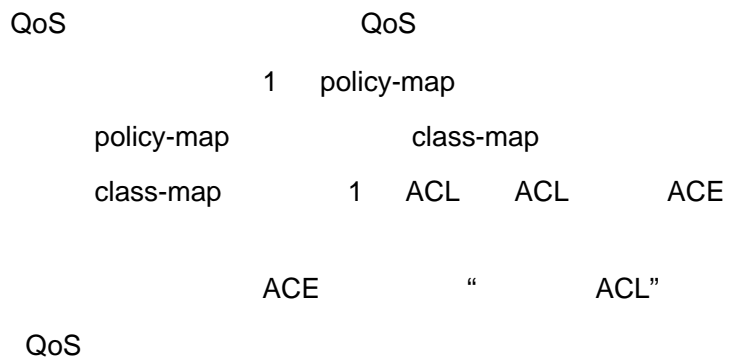

CoS to DSCP	CoS	DSCP
	0	0
	1	8
	2	16
	3	24
	4	32
	5	40
	6	48
	7	56

IP-Precedence to DSCP

IP-Precede nce to DSCP	IP-Precedence	DSCP
	0	0
	1	8
	2	16
	3	24
	4	32
	5	40
	6	48
	7	56

DSCP to CoS

DSCP to CoS	DSCP	CoS
	0	0
	8	1
	16	2
	24	3
	32	4
	40	5
	48	6
	56	7

S29	DRR Weight Range
-----	------------------

41.2

41.2.1 class maps

ACL

ip access-list {**extended** | **standard**} { *acl-id* | *acl-name* }

mac access-list extended {*acl-id* | *acl-name*}

expert access-list extended {*acl-id* | *acl-name*}

ipv6 access-list extended *acl-name*

access-list *acl-id* ACL

class map class map

[**no**] **class-map** *class-map-name*

class map

[**no**] **match access-group** *acl-name*| *acl-id*

<i>acl-name</i>	ACL
<i>acl-id</i>	ACL id
<i>class-map-name</i>	class map
no class-map <i>class-map-name</i>	class map
no match access-group <i>acl-name</i> <i>acl-id</i>	

```

1      MAC ACL, me
Ruijie(config)# mac access-list extended me
2      ACL
Ruijie(config-ext-macl)# permit host 1111.2222.3333 any
3      ACL
Ruijie(config-ext-macl)# exit

```

	show mls qos queueing	-
	-	-

41.2.3 interface rate-limit

rate-limit {input | output} *bps burst-size*

no rate-limit

	input	
	output	
	<i>bps</i>	
	<i>burst-size</i>	(Kbyte)dscp-list
	no	

┌

┌

┌

┌

```
Ruijie(config)# interface fastEthernet 0/1
Ruijie(config-if)# rate-limit input 1000000 4096
```

	show mls qos interface	-

	-	-
--	---	---

41.2.4 mls qos cos

CoS

mls qos cos *default-cos*

no mls qos cos

	<i>default-cos</i>	0 7
	no	

┌

CoS 0

┌

┌

┌
Ruijie(config)# **interface gigabitethernet 1/1**
Ruijie(config-if)# **mls qos cos 7**

┌

	show mls qos interface <i>interface-id</i>	-

	dscp	
	no	

|

|

|

Ruijie(config)# **mls qos map cos-dscp 8 10 16 18 24 26 32 34**

	show mls qos maps	dscp-cos maps,dscp-cos maps ip-prec-dscp maps

|

	-	-

41.2.6 mls qos map dscp-cos

DSCP CoS

mls qos map dscp-cos *dscp-list to cos*

no mls qos map dscp-cos

	<i>dscp-list</i>	
	cos	

Ruijie(config)# ~~mls qos~~ ~~mls qos~~

41.2.8 mls qos scheduler

mls qos scheduler [sp | wrr | drr]

no mls qos scheduler

sp	
wrr	
drr	
no	

wrr

dscp	Qos	DSCP
<i>ip-precedence</i>	Qos	IP-PRE
no		

└───

└───

policy-map-name

[no] priority-queue

priority-queue	SP (S2900)
no priority-queue	WRR

WRR

8

-	-

41.3

41.3.1 show class-map

class map

show class-map [*class-name*]

<i>class-name</i>	class map

class map

Ruijie# **show class-map**

-	-

S2900

-	-

41.3.2 show policy-map

QoS policy map [class *class-name*]

show policy-map [*policy-name* [**class** *class-name*]]

<i>policy-name</i>	policy name

<i>class-name</i>	class map
-------------------	-----------

policy name

Ruijie# **show policy-map**

-	-

-	-

41.3.3 show mls qos interface

QoS

show mls qos interface *interface-id* [**policers**]

<i>interface-id</i>	
policers	police

QoS

Ruijie# **show mls qos interface fastEthernet 0/1**

--	--

show mls qos queueing

		ΣΕÄ
	-	-

|

|

|

Ruijie#

	-	-

┌

	-	-

41.3.7 show mls qos scheduler

show mls qos scheduler

	-	-

┌

┌

┌

Ruijie# show mls qos scheduler

	-	-

┌

	-	-

42 Voice VLAN

42.1

42.1.1 voice vlan

```
          Voice VLAN          VLAN  Voice VLAN          no
Voice VLAN
voice vlan vlan-id
no voice vlan
```

<i>vlan-id</i>	Voice VLAN	ID

┌

┌

Voice VLAN Remot /C2_0 1 Tf0 Tc 0 A/C2_5036f-0.006d

	show voice vlan	Voice VLAN
	10.4	

42.1.2 voice vlan aging

	Voice VLAN	no
	voice vlan aging <i>minutes</i>	
	no voice vlan aging	
	<i>mn aging</i>	

	<i>dscp-value</i>	Voice VLAN	DSCP
	<i>dscp-value</i>	46	
		Voice VLAN	CoS DSCP
	1	Voice VLAN	DSCP 40
	Ruijie(config)# voice vlan dscp 40		
	show voice vlan		Voice VLAN
	S29		
	10.4		

42.1.5 voice vlan enable

	Voice VLAN	Voice VLAN	no
	voice vlan enable		
	no voice vlan enable		
		Voice VLAN	
		Voice VLAN	Voice VLAN
	Access Port	Trunk Port	Hybrid Port Private VLAN Private VLAN

```

1      OUI      0012.3400.0000  Voice VLAN      Company A
Ruijie(config)# voice vlan mac-address 0012.3400.0000 mask
ffff.ff00.0000 description Company A
    
```

show voice vlan oui	OUI OUI

```

```

10.4	

42.1.7 voice vlan mode auto

```

Voice VLAN
Voice VLAN
no
voice vlan mode auto
no voice vlan mode auto
    
```

```

Voice VLAN
    
```

```

```

```

Voice VLAN
Voice VLAN
Voice VLAN
Voice VLAN
IP
Voice VLAN
    
```

1 Voice VLAN
 Voice VLAN Voice VLAN

2
 native VLAN Voice VLAN

3 Trunk Port/Hybrid Port VLAN
 Voice VLAN VLAN Voice
VLAN Voice VLAN

┌

├

	Voice VLAN	Voice VLAN	Voice VLAN ,X] < õ ã Ä
' Ô] < õ ã âA' Û î í y [,X\$d	MAC	MAC	
Voice VLAN OUI	untagged	Voice VLAN	Voice VLAN tag
MAC		Voice VLAN tag	
VLAN		Voice	/

├

1 Ö ' Ô Voice VLAN
 Ruijie(config)# voice vlan security enable

├

¥ K€	£ EÄ
------	------

,XySA'7QH yQD(BD)]<1Td<278>6<09TT0 1 Tf-0.88AC4>5.988 Tc 1.252 0 T3 458.9 0.24 1.5 ref13714

Voice VLAN

Voice VLAN

```

1          Voice VLAN
Ruijie(config)# show voice vlan
Voice VLAN status: ENABLE           //Voice VLAN
Voice VLAN ID: 2                     //Voice VLAN ID
Voice VLAN security mode: Security  //
Voice VLAN aging time: 5 minutes    //
Voice VLAN cos: 6                    //      CoS
Voice VLAN dscp: 46                  //      DSCP
Current voice vlan enabled port mode: //      Voice VLAN
PORT                                MODE
-----
Fa0/1                                Auto
    
```

	Voice VLAN	Voice VLAN
voice vlan <i>vlan-id</i>	Voice VLAN VLAN	Voice VLAN
voice vlan aging <i>minutes</i>	Voice VLAN	
voice vlan cos <i>cos-value</i>	Voice VLAN	CoS
voice vlan dscp <i>dscp-value</i>	Voice VLAN	DSCP
voice vlan enable	Voice VLAN	
voice vlan mode auto	Voice VLAN	
voice vlan security enable	Voice VLAN	

10.4

Voice VLAN

--	--	--

┌

┌

43

43.1

43.1.1 rgos-security compatible

44 RLDP

44.1

44.1.1 rldp detect-interval

RLDP

rldp detect-interval *interval*

no rldp detect-interval

	<i>interval</i>	2-15
	3	

rldp detect-max *num*

no rldp detect-max

	<i>num</i>	, 2-10

2

5

Ruijie(config)# **rldp detect-max 5**

	rldp detect-interval	

	-	-

44.1.3 rldp enable

RLDP

rldp enable

no rldp enable

--	--	--

RLDP RLDP

Ruijie(config)# **rldp enable**

rldp port	RLDP

-	-

44.1.4 rldp port

rldp

rldp port { unidirection-detect | bidirection-detect | loop-detect } { warning | shutdown-svi | shutdown-port | block }

no rldp port { unidirection-detect | bidirection-detect | loop-detect }

unidirection-detect	
bidirection-detect	
loop-detect	
warning	
shutdown-svi	shutdown svi
shutdown-port	shutdown
block	

```
Ruijie(config)# interface fas 0/1  
Ruijie(config-if)# rldp port loop-detect block
```

44.2

44.2.1 show rldp

rldp

show rldp [interface *interface-id*]

	<i>Interface-id</i>	
	EXEC	
	-	-
	-	-

44.2.2 debug rldp

rldp

no

debug rldp [packet | event | error]

undebug rldp [packet | event | error]

	packet	rldp
	event	
	error	

└──

└── EXEC

└──

└──

	-	-

└──

	-	-

45 TPP

45.1

45.1.1 topology guard

topology guard

no

[no] topology guard

-	-

┌

┌

┌

cpu topology-limit

Ruijie(config)# topology guard
 Ruijie(config)# no topology guard

┌

tp-guard port enable	
cpu topology-limit	CPU

┌

-	-

45.1.2 tp-guard port enable

no

[no] tp-guard port enable



|

|

tpp

|

Ruijie# **show tpp**

|

topology guard	

|

|

-	-

46

46.1

46.1.1 cd

`cd [filesystem:][directory]`

<i>filesystem</i>	" "
<i>directory</i>	

flash

cd " /" pwd

1 usb0
Ruijie# **cd** usb0:/
2 sd
Ruijie# **cd** sd0:/

pwd	

46.1.2 copy

copy *source-url destination-url*

<i>source-url</i>	URL
<i>destination-url</i>	URL

copy

URL

flash:	flash URL flash
tftp:	TFTP
xmodem:	xmodem
slave:	flash
usb0:	usb
usb1:	usb
sd0:	sd

URL

1 tftp

```

Ruijie#copy tftp://192.168.201.54/rgos.bin flash:/
  2          tftp
Ruijie#copy flash:/rgos.bin tftp://192.168.201.54/rgos.bin
  3          xmodem
Ruijie# copy xmodem: flash:/config.text
  4          U
Ruijie#copy flash:/config.text usb0:/config.text
  5
Ruijie#copy flash:/config.text slave:/config.text
  6          flash      sd
Ruijie#copy flash:/rgos.bin sd0:/rgos.bin
  7          U          sd
Ruijie#copy usb0:/config.text sd0:/config.text
  8          sd          U
Ruijie#copy sd0:/config.text usb0:/config.text

```

del	
rename	
dir	

46.1.3 delete

delete url

<i>url</i>	<i>url</i>

	url	URL	flash/
	usb0:/ usb1:/slave/	url	
			.

```

1          tmpfile
Ruijie# delete tmpfile
2          rgos.bin.bak
Ruijie# delete slave:/rgos.bin.bak
3          sd      aaa.bin
Ruijie# delete sd0:/aaa.bin

```

copy	
dir	

46.1.4 dir

dir [*filesystem*][: *directory*]

<i>filesystem</i>	”.”
<i>directory</i>	

46.1.5 mkdir

mkdir *directory*

<i>directory</i>	

()

flash:/backup/temp flash:/backup
flash:/bakcup

flash:/backup/temp

1 test
Ruijie# **mkdir** test

2 sd test2
Ruijie# **mkdir** sd0:/test2

46.1.6 rename

rename /url?url? ~~_____~~ aÑ „

pwd



└──

└──

└──

1
Ruijie#show file systems

└──

└──

└──

47

47.1 CPU

47.1.1 cpu-log

CPU , **cpu-log**
cpu-log *log-limit low_num high_num*

5	0%	0%	0%	waitqueue_process
6	0%	0%	0%	tasklet_task
7	0%	0%	0%	kevents
8	0%	0%	0%	snmpd
9	0%	0%	0%	snmp_trapd
10	0%	0%	0%	mtdblock
11	0%	0%	0%	gc_task
12	0%	0%	0%	Context
13	0%	0%	0%	kswapd
14	0%	0%	0%	bdflush
15	0%	0%	0%	kupdate
16	0%	3%	1%	ll_mt
17	0%	0%	0%	ll main process
18	0%	0%	0%	bridge_relay
19	0%	0%	0%	dlx_task
20	0%	0%	0%	secu_policy_task
21	0%	0%	0%	dhcpa_task
22	0%	0%	0%	dhcpsnp_task
23	0%	0%	0%	igmp_snp
24	0%	0%	0%	mstp_event
25	0%	0%	0%	GVRP_EVENT
26	0%	0%	0%	rldp_task
27	0%	2%	1%	rerp_task
28	0%	0%	0%	reup_event_handler
29	0%	0%	0%	tpp_task
30	0%	0%	0%	ip6timer
31	0%	0%	0%	rtadvd
32	0%	0%	0%	tnet6
33	2%	0%	0%	tnet
34	0%	0%	0%	Tarptime
35	0%	0%	0%	gra_arp
36	0%	0%	0%	Ttcptimer
37	8%	1%	0%	ef_res
38	0%	0%	0%	ef_rcv_msg
39	0%	0%	0%	ef_inconsistent_daemon
4t_daemon				
4t_daemon				
4t_dvmp_snp	17	0%	39	0%

44	0%	0%	0%	ef6_inconsistent_daemon
45	0%	0%	0%	imid
46	0%	0%	0%	nsmd
47	0%	0%	0%	ripd
48	0%	0%	0%	ripngd
49	0%	0%	0%	ospfd
50	0%	0%	0%	ospf6d
51	0%	0%	0%	bgpd
52	0%	0%	0%	pimd
53	0%	0%	0%	pim6d
54	0%	0%	0%	pdmd
55	0%	0%	0%	dvmrpd
56	0%	0%	0%	vty_connect
57	0%	0%	0%	aaa_task
58	0%	0%	0%	Tlogtrap
59	0%	0%	0%	dhcp6c
60	0%	0%	0%	sntp_recv_task
61	0%	0%	0%	ntp_task
62	0%	0%	0%	sla_daemon
63	0%	3%	1%	track_daemon
64	0%	0%	0%	pbr_guard
65	0%	0%	0%	vrrpd
66	0%	0%	0%	psnpd
67	0%	0%	0%	igsnpd
68	0%	0%	0%	coa_recv
69	0%	0%	0%	co_oper
70	0%	0%	0%	co_mac
71	0%	0%	0%	radius_task
72	0%	0%	0%	tac+_acct_task
73	0%	0%	0%	tac+_task
74	0%	0%	0%	dhcpd_task
75	0%	0%	0%	dhcps_task
76	0%	0%	0%	dhcpping_task
77	0%	0%	0%	dhcpc_task
78	0%	0%	0%	uart_debug_file_task
79	0%	0%	0%	ssp_init_task
80	0%	0%	0%	rl_listen
81	0%	0%	0%	ikl_msg_operate_thread
82	0%	0%	0%	bcmDPC

83	0%	0%	0%	bcmL2X.0	
84	3%	3%	3%	bcmL2X.0	
85	0%	0%	0%	bcmCNTR.0	
86	0%	0%	0%	bcmTX	
87	0%	0%	0%	bcmXGS3AsyncTX	
88	0%	2%	1%	bcmLINK.0	
89	0%	0%	0%	bcmRX	
90	0%	0%	0%	mngpkt_rcv_thread	
91	0%	0%	0%	mngpkt_recycle_thread	
92	0%	0%	0%	stack_task	
93	0%	0%	0%	stack_disc_task	
94	0%	0%	0%	redun_sync_task	
95	0%	0%	0%	conf_dispatch_task	
96	0%	0%	0%	devprob_task	
97	0%	0%	0%	rdp_snd_thread	
98	0%	0%	0%	rdp_rcv_thread	
99	0%	0%	0%	rdp_slot_change_thread	
100	4%	2%	1%	datapkt_rcv_thread	
101	0%	0%	0%	keepalive_link_notify	
102	0%	0%	0%	rerp_msg_rcv_thread	
103	0%	0%	0%	ip_scan_guard_task	
104	0%	0%	0%	ssp_ipmc_hit_task	
105	0%	0%	0%	ssp_ipmc_trap_task	
106	0%	0%	0%	hw_err_snd_task	
107	0%	0%	0%	rerp_packet_send_task	
108	0%	0%	0%	idle_vlan_proc_thread	
109	0%	0%	0%	cmic_pause_detect	
110	1%	1%	1%	stat_get_and_send	
111	0%	1%	0%	rl_con	
112	75%	80%	90%	idle	
		3	5	1	5
	CPU	LISR	HISR		CPU

No	
5Sec	5 CPU
1Min	1 CPU
5Min	5 CPU

2

,X

bgp

1 BGP
Ruijie(config)# **memory-lack exit-policy bgp**

show memory	
-	
10.3(4b3)	

47.2.2 show memory

show memory

show memory

-	-

└───┘

└───┘

└───┘

└───┘

show memory

Ruijie#show memory

System Memory Statistic:

Free pages: 1079

watermarks : min 379, lower 758, low 1137, high 1516

System Total Memory : 128MB, Current Free Memory : 5283KB

Used Rate : 96%

1. 4k

2.

min	
lower	memory-lack exit-policy
low	OVERFLOW
high	OVERFLOW

3.

-	-

-	-

47.2.3 show memory protocols

show memory protocols



48

48.1

48.1.1 clear logging

clear logging

	-	-

└───

└───

└───

└───
Ruijie# clear logging

	logging on	
	show logging	
	logging buffered	

└───

	-	-

48.1.2 more flash

FLASH

more flash:filename

<i>Filename</i>	

└──

└──

└──

FLASH "/f2/" "/f3/

└──

FLASH

```
Ruijie# more flash://f2/log.txt
look up file in the extended flash://f2/log.txt
00004 2004-11-17 4:1:32 Ruijie: %5:Reload requested by
Administrator. Reload Reason :Reload command
```

└──

logging file flash:	FLASH

└──

└──

-	-

48.1.3 logging buffered

no

default

logging buffered [*buffer-size* | *level*]

no logging buffered

default logging buffered

└──

--	--

buffer-size

4K 128K Bytes

<i>levell</i>	0 7
---------------	-----



4k Bytes

7



show logging

clear logging

FLASH

Syslog Server

8

Emergencies	0	
Alerts	1	

	-	-

48.1.4 logging console

no

logging console level

no logging console

<i>level</i>		0 7
		1

Debugging (7)

show logging

6
Ruijie(config)# **logging console informational**

logging on		
show logging		

	-	-

48.1.5 logging count

no

logging count

no logging count

	-	-

|

|

|

no logging count

|

Ruijie(config)# **logging count**

show logging count		
show logging		

|

	-	-

48.1.6 logging facility

no

(23)

logging facility *facility-type*

no logging facility

<i>facility-type</i>	Syslog
----------------------	--------

Local7(23)

2 Syslog

Numerical Code	Facility
0	kernel messages
1	user-level messages
2	mail system
3	system daemons
4	security/authorization messages
5	messages generated internally by syslogd
6	line printer subsystem
7	network news subsystem
8	UUCP subsystem
9	clock daemon
10	security/authorization messages
11	FTP daemon
12	NTP subsystem
13	log audit
14	log alert
15	clock daemon
16	local use 0 (local0)
17	local use 1 (local1)
18	local use 2 (local2)
19	local use 3 (local3)
20	local use 4 (local4)
21	local use 5 (local5)
22	local use 6 (local6)
23	local use 7 (local7)

(local7) 23

Syslog kernel

Ruijie(config)# logging facility kern

logging console	

-	-

48.1.7 logging file flash

FLASH

FLASH

no

logging file flash:filename [*max-file-size*] [*level*]

no logging file

<i>Filename</i>	txt
<i>max-file-size</i>	128K 6M bytes
	128K
<i>level</i>	FLASH 6
	1

FLASH

Syslog Server

FLASH

txt

	FLASH	FLASH
	FLASH logging file flash	
	FLASH	trace.txt
6		64K,
	Ruijie(config)# logging file flash:trace	
	logging on	
	show logging	
	more flash	FLASH
	-	-

48.1.8 logging monitor

	VTY	telnet	SSH
		no	VTY
	logging monitor level		
	no logging monitor		
	level		1
	Debugging (7)		
	VTY		terminal monitor
	VTY		logging monitor
	Logging monitor		VTY

VTY

6

Ruijie(config)# **logging monitor informational**

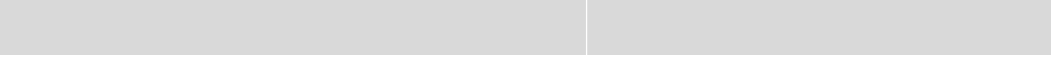

logging	Syslog Server
logging file flash:	FLASH
logging console	
logging monitor	VTY (telnet)
logging trap	Syslog Server

-	-

48.1.10 logging rate-limit

no

logging rate-limit {*number* | *all number* | *console {number | all number}*} [*except severity*]

no logging rate-limit

<i>number</i>	1—10000
<i>all</i>	0—7
<i>console</i>	
<i>except</i>	error(3) error
<i>severity</i>	0—7

debug 10 warning

Ruijie(config)#**logging rate-limit all 10 except warnings**

show logging count	
show logging	

2 IPV6 AAAA:BBBB::FFFF
Ruijie(config)# **logging server ipv6 AAAA:BBBB::FFFF**

logging on	
show logging	
logging trap	syslog server

	-	-
--	---	---

48.1.14 logging synchronous

no

logging synchronous

no logging synchronous

	-	-

┌
└
┌
└
┌
└

```
Ruijie(config)#line console 0
Ruijie(config-line)#logging synchronous
                        UP-DOWN
Ruijie#configure terminal
Oct  9 23:40:55 %LINK-5-CHANGED: Interface GigabitEthernet 0/1,
changed state to down
Oct  9 23:40:55 %LINEPROTO-5-UPDOWN: Line protocol on Interface
GigabitEthernet 0/1, changed state to DOWN
Ruijie# configure terminal //
```

	show running-config	

┌
└
┌
└

48.1.15 logging trap

		Syslog Server		
	no		Syslog Server	
	logging trap	<i>level</i>		
	no logging trap			
	<i>level</i>		1	
		Informational(6)		
		Server	Syslog Server	logging Syslog
			logging trap	
	show logging			
		6	202.101.11.22	Syslog Server
	Ruijie(config)#	logging	202.101.11.22	
	Ruijie(config)#	logging trap informational		
	logging on			
	logging		Syslog Server	
	show logging			
		-	-	

48.1.16 service sequence-numbers

no

service sequence-numbers

no service sequence-numbers



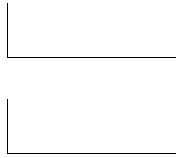

```
Mar 22 15:28:02 %SYS-5-CONFIG: Configured from console by console
Ruijie# config terminal
Enter configuration commands, one per line. End with CNTL/Z.
Ruijie(config)#
```

<i>msec</i>	Jul 27 16:53:07.299
<i>year</i>	2007 Jul 27 16:53:07

RTC

Uptime
Datetime

Log Debug Datetime

```
Ruijie(config)# service timestamps debug datetime msec
Ruijie(config)# service timestamps log datetime msec
Ruijie(config)# end
Ruijie(config)# Oct 8 23:04:58.301 %SYS-5-CONFIG_I: Configured from
console by console
```

logging on	
service sequence-numbers	

-	-

48.1.19 terminal monitor

```

VTY
no
terminal monitor
terminal no monitor

```

	-	-

show logging

```
Ruijie# show logging
Syslog logging: enabled
Console logging: level debugging, 4 messages logged
Monitor logging: level informational, 0 messages logged
Buffer logging: level debugging, 6 messages logged
Timestamp debug messages: datetime
Timestamp log messages: disabled
Sequence log messages: enable
Trap logging: level debugging, 2 message lines logged,0 reserved,0
fail
logging to 202.101.11.22
logging to 192.168.200.112
Log Buffer (Total 4096 Bytes) : have written 680
00001 2004-11-17 10:20:59 Ruijie: %7:%LINK CHANGED: Interface
FastEthernet 0/0, changed state to up
00002 2004-11-17 10:20:59 Ruijie: %7:%LINE PROTOCOL CHANGE:
Interface FastEthernet 0/0, changed state to UP
00003 2004-11-17 10:57:18 Ruijie: %7:%LINK CHANGED: Interface
FastEthernet 0/1, changed state to administratively down
00004 2004-11-17 10:57:21 Ruijie: %7:%LINK CHANGED: Interface
FastEthernet 0/1, changed state to down
00005 2004-11-17 10:57:41 Ruijie: %7:%LINK CHANGED: Interface
FastEthernet 0/1, changed state to administratively down
00006 2004-11-17 10:57:43 Ruijie: %7:%LINK CHANGED: Interface
FastEthernet 0/1, changed state to down
```

Syslog logging	enabled, disabled
Console logging	
Monitor logging	VTY
Buffer logging	
Timestamp debug messages	Debug
Timestamp log messages	Log
Sequence log messages	

	logging count	
	show logging	
	clear logging	
	-	-

49

49.1

49.1.1 device-description

device-description [*member member*] *description*

<i>member</i>	1-MAX, .
<i>description</i>	31,

SWITCH

show member

2 red-giant
Ruijie(config)# **device-description member 2 red-giant**

show member [<i>member</i>]	member

-	-

49.1.2 device-priority

device-priority [*member*] *priority*

```
Ruijie(config)# member 2
Ruijie@2(config)# exit
Ruijie(config)#
```

-	-

-	-

49.1.4 stack

stack {on | off} [copper | fiber]

on	
off	
copper	
fiber	

,

```
: : , - - . ,
ID
```

2 gigabitEthernet 0/3

```
Ruijie(config)# interface gigabitEthernet 2/0/3
Ruijie(config-if)# stack on
```

--	--

	show stack interface	
	S2900	switch port
	-	-

49.1.5 synchronize

synchronize flash: *filename*

--	--

49.2.1 show member

show member [*member*]

<i>member</i>	1-MAX, .

|

|

|

Member	Mac Address	Priority	Software Ver	Hardware Ver
Description				
-----	-----	-----	----	-----
1	00d0.f822.3100	1	RGOS 10.1 1.0	SWITCH
2	00d3.f822.33aa	1	RGOS 10.1 1.0	SWITCH
3	00d3.f824.33ac	1	RGOS 10.1 1.0	SWITCH

show stack interface

	-	-
